

Agilent 8614xB Series
Optical Spectrum Analyzer
User's Guide



Agilent Technologies

Notices

This document contains proprietary information that is protected by copyright. All rights are reserved.

No part of this document may reproduced in (including electronic storage and retrieval or translation into a foreign language) without prior agreement and written consent from Agilent Technologies Deutschland GmbH as governed by United States and international copyright laws.

Copyright 2001-2004 by:
Agilent Technologies Deutschland GmbH
Herrenberger Str. 130
71034 Böblingen
Germany

Subject Matter

The material in this document is subject to change without notice.

Agilent Technologies makes no warranty of any kind with regard to this printed material, including, but not limited to, the implied warranties of merchantability and fitness for a particular purpose.

Agilent Technologies shall not be liable for errors contained herein or for incidental or consequential damages in connection with the furnishing, performance, or use of this material.

Printing History

New editions are complete revisions of the guide reflecting alterations in the functionality of the instrument. Updates are occasionally made to the guide between editions. The date on the title page changes when an updated guide is published. To find out the current revision of the guide, or to purchase an updated guide, contact your Agilent Technologies representative.

Warranty

This Agilent Technologies instrument product is warranted against defects in material and workmanship for a period of one year from date of shipment. During the warranty period, Agilent will, at its option, either repair or replace products that prove to be defective.

For warranty service or repair, this product must be returned to a service facility designated by Agilent. Buyer shall prepay shipping charges to Agilent and Agilent shall pay shipping charges to return the product to Buyer. However, Buyer shall pay all shipping charges, duties, and taxes for products returned to Agilent from another country.

Agilent warrants that its software and firmware designated by Agilent for use with an instrument will execute its programming instructions when properly installed on that instrument.

Agilent does not warrant that the operation of the instrument, software, or firmware will be uninterrupted or error free.

Limitation of Warranty

The foregoing warranty shall not apply to defects resulting from improper or inadequate maintenance by Buyer, Buyer-supplied software or interfacing, unauthorized modification or misuse, operation outside of the environmental specifications for the product, or improper site preparation or maintenance.

No other warranty is expressed or implied. Agilent Technologies specifically disclaims the implied warranties of Merchantability and Fitness for a Particular Purpose.

Exclusive Remedies

The remedies provided herein are Buyer's sole and exclusive remedies. Agilent Technologies shall not be liable for any direct, indirect, special, incidental, or consequential damages whether based on contract, tort, or any other legal theory.

Assistance

Product maintenance agreements and other customer assistance agreements are available for Agilent Technologies products. For any assistance contact your nearest Agilent Technologies Sales and Service Office.

Certification

Agilent Technologies Inc. certifies that this product met its published specifications at the time of shipment from the factory.

Agilent Technologies further certifies that its calibration measurements are traceable to the United States National Institute of Standards and Technology, NIST (formerly the United States National Bureau of Standards, NBS) to the extent allowed by the Institutes's calibration facility, and to the calibration facilities of other International Standards Organization members.

ISO 9001 Certification

Produced to ISO 9001 international quality system standard as part of our objective of continually increasing customer satisfaction through improved process control.

Fourth Edition:

86140 - 90U03: June 10, 2005

Third Edition:

86140 - 90U03: May 15, 2004

Second Edition:

86140 - 90068: January 1, 2002

First Edition:

86140 - 90035: February 1, 2000

Safety Symbols.
CAUTION

The *caution* sign denotes a hazard. It calls attention to a procedure which, if not correctly performed or adhered to, could result in damage to or destruction of the product. Do not proceed beyond a caution sign until the indicated conditions are fully understood and met.

WARNING

The *warning* sign denotes a hazard. It calls attention to a procedure which, if not correctly performed or adhered to, could result in injury or loss of life. Do not proceed beyond a warning sign until the indicated conditions are fully understood and met.

 The instruction manual symbol. The product is marked with this warning symbol when it is necessary for the user to refer to the instructions in the manual.

 The laser radiation symbol. This warning symbol is marked on products which have a laser output.

 The AC symbol is used to indicate the required nature of the line module input power.

 The ON symbols are used to mark the positions of the instrument power line switch.

 The OFF symbols are used to mark the positions of the instrument power line switch.

 The CE mark is a registered trademark of the European Community.

 The CSA mark is a registered trademark of the Canadian Standards Association.

 The C-Tick mark is a registered trademark of the Australian Spectrum Management Agency.

ISM1-A This text denotes the instrument is an Industrial Scientific and Medical Group 1 Class A product.

Typographical Conventions.

The following conventions are used in this book:

Key type for keys or text located on the keyboard or instrument.

Softkey type for key names that are displayed on the instrument's screen.

Display type for words or characters displayed on the computer's screen or instrument's display.

User type for words or characters that you type or enter.

Emphasis type for words or characters that emphasize some point or that are used as place holders for text that you type.

General Safety Considerations

This product has been designed and tested in accordance with the standards listed on the Manufacturer's Declaration of Conformity, and has been supplied in a safe condition. The documentation contains information and warnings that must be followed by the user to ensure safe operation and to maintain the product in a safe condition.

Install the instrument according to the enclosure protection provided.

This instrument does not protect against the ingress of water.

This instrument protects against finger access to hazardous parts within the enclosure.

WARNING	If this product is not used as specified, the protection provided by the equipment could be impaired. This product must be used in a normal condition (in which all means for protection are intact) only.
WARNING	No operator serviceable parts inside. Refer servicing to qualified service personnel. To prevent electrical shock do not remove covers.
WARNING	This is a Safety Class 1 Product (provided with protective earth). The mains plug shall only be inserted in a socket outlet provided with a protective earth contact. Any interruption of the protective conductor inside or outside of the instrument is likely to make the instrument dangerous. Intentional interruption is prohibited.
WARNING	To prevent electrical shock, disconnect the instrument from mains before cleaning. Use a dry cloth or one slightly dampened with water to clean the external case parts. Do not attempt to clean internally.
CAUTION	Fiber-optic connectors are easily damaged when connected to dirty or damaged cables and accessories. The Agilent 8614x series's front-panel INPUT connector is no exception. When you use improper cleaning and handling techniques, you risk expensive instrument repairs, damaged cables, and compromised measurements. Before you connect any fiber-optic cable to the Agilent 8614x series, refer to "Cleaning Connections for Accurate Measurements" on page 6-8.
CAUTION	This product complies with Overvoltage Category II and Pollution Degree 2.
CAUTION	Do not use too much liquid in cleaning the optical spectrum analyzer. Water can enter the front-panel keyboard, damaging sensitive electronic components.
CAUTION	VENTILATION REQUIREMENTS: When installing the product in a cabinet, the convection into and out of the product must not be restricted. The ambient temperature (outside the cabinet) must be less than the maximum operating temperature of the product by 4× C for every 100 watts dissipated in the cabinet. If the total power dissipated in the cabinet is greater than 800 watts, then forced convection must be used.
CAUTION	Install the instrument so that the detachable power cord is readily identifiable and is easily reached by the operator. The detachable power cord is the instrument disconnecting device. It disconnects the mains circuit from the mains supply before other parts of the instrument. The front panel switch

General Safety Considerations

is only a standby switch and is not a LINE switch. Alternatively, an externally installed switch or circuit breaker (which is readily identifiable and is easily reached by the operator) may be used as a disconnecting device.

CAUTION

Always use the three-prong AC power cord supplied with this instrument. Failure to ensure adequate earth grounding by not using this cord may cause instrument damage.

CAUTION

Do not connect ac power until you have verified the line voltage is correct as described in "Line Power Requirements" on page 1-10. Damage to the equipment could result.

CAUTION

This instrument has autoranging line voltage input. Be sure the supply voltage is within the specified range.

CAUTION

The Agilent 8614xB contain a light source classified, according to IEC 60825-1.

CAUTION

Use of controls or adjustment or performance of procedures other than those specified herein may result in hazardous radiation exposure.

Contents

- 1 Getting Started
 - Product Overview 1-2
 - Setting Up the Analyzer 1-8
 - Making a Measurement 1-12
 - The Menu Bar 1-15
 - The Softkey Panels 1-16
 - Laser Safety Information 1-27
 - Product Options and Accessories 1-28

- 2 Using the Instrument
 - Setting Up Measurements 2-2
 - Calibrating Wavelength Measurements 2-13
 - Saving, Recalling, and Managing Files 2-18
 - Analyzing Measurement Data 2-26
 - Analyzer Operating Modes 2-29

- 3 Function Reference

- 4 Remote Front Panel Operation
 - Remote Front Panel 4-2

- 5 Status Listings
 - Overview 5-2
 - Error Reporting Behavior 5-4
 - SCPI-Defined Errors 5-5
 - OSA Notices 5-16
 - OSA Warnings 5-17
 - Application-Specific Warnings 5-29
 - OSA Status Errors 5-35
 - OSA Errors 5-36
 - Firmware Errors 5-38

- 6 Maintenance
 - Changing the Printer Paper 6-2
 - Printer Head Cleaning Procedure 6-4
 - Cleaning Connections for Accurate Measurements 6-8
 - Returning the Instrument for Service 6-21

Contents

7	Specifications and Regulatory Information
	Definition of Terms 7-3
	Specifications 7-5
	Regulatory Information 7-19
	Declaration of Conformity 7-20

1

Product Overview	1-2
Setting Up the Analyzer	1-8
Making a Measurement	1-12
The Menu Bar	1-15
The Softkey Panels	1-16
Laser Safety Information	1-26
Product Options and Accessories	1-27

Getting Started

Product Overview

The 8614xB series of optical spectrum analyzers provide fast, accurate, and comprehensive measurement capabilities for spectral analysis.

- Full-featured SCPI commands for programming instruments over LAN
- Display-off feature for making faster measurements
- Remote file saving and printing for outputting measurement results
- Filter mode for accurate and flexible measurements
- Built-in applications for accelerating test times

Filter Mode

The Agilent 86146B filter mode allows single dense wavelength division multiplexing (DWDM) to be isolated and routed to external test equipment. The filter mode capability is built-in to internal applications to allow for fast and easy implementation of channel dropping. For Agilent 86146B instruments, this mode also allows the ability to measure time resolve chirp (TRC).

Built-in Applications

Built-in applications allow fast, repeatable measurements for WDM systems, lasers, amplifiers, and passive components. These applications can be added through a firmware upgrade.

WDM Application

This application allows you to measure DWDM sub-system components, (such as transmission sub-systems, optical add/drop multiplexers, and multiplexers/de-multiplexers) for parameters such as optical signal-to-noise ratio (OSNR), channel wavelength, channel power, and span tilt.

Passive Component Test Application

This application simplifies the testing of passive components, such as filters, couplers, and isolators by defining a test plan that measures parameters such as insertion and return loss, bandwidth, and filter shape.

Source Test Application

This application offers automated optical source and laser characterization.

Amplifier Test Application

This application simplifies the process of characterizing gain and noise figure of optical amplifiers such as EDFA's, SOA's and Raman amplifiers.

Agilent 8614xB Front and Rear Panels

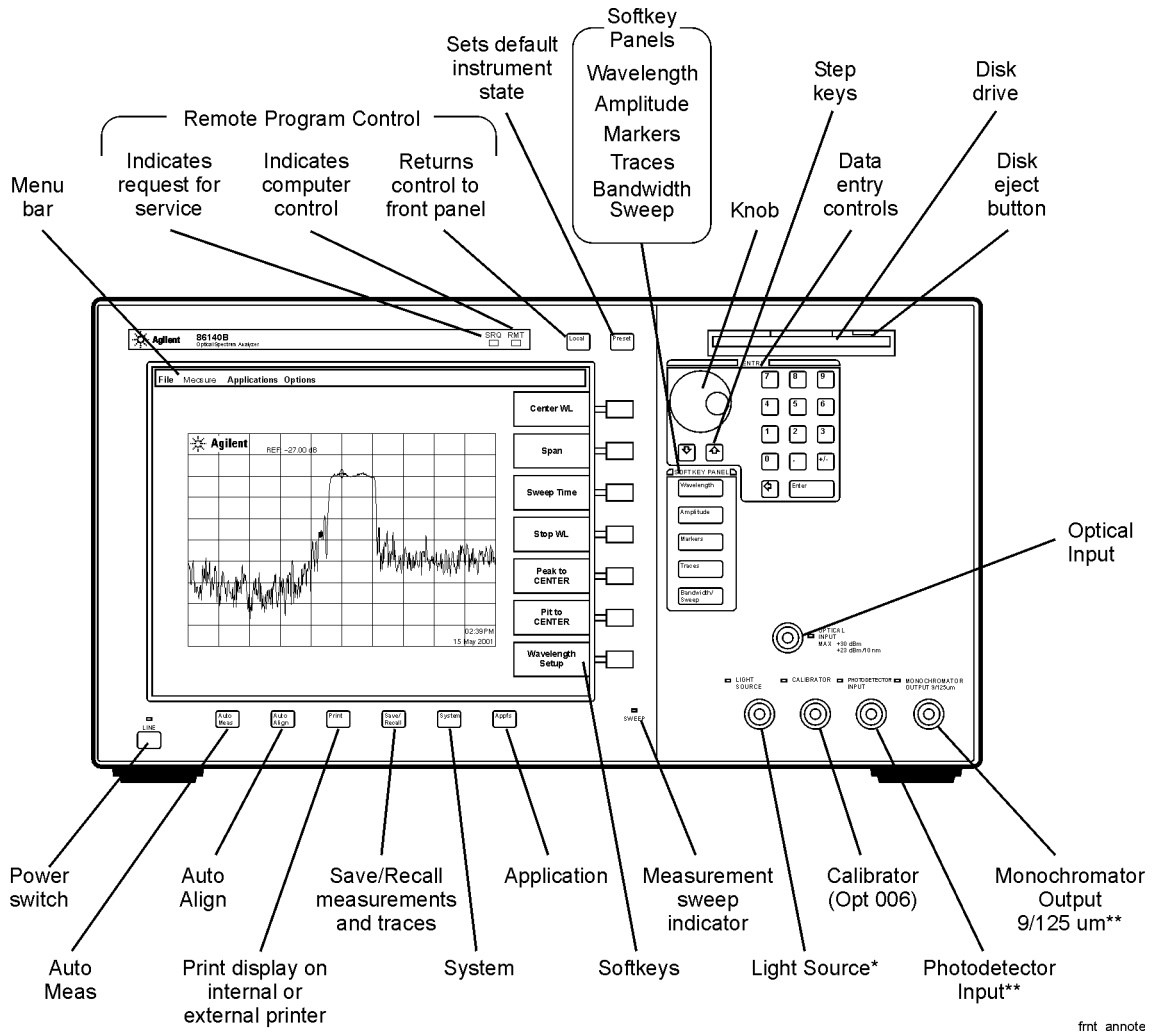

fnt_annot

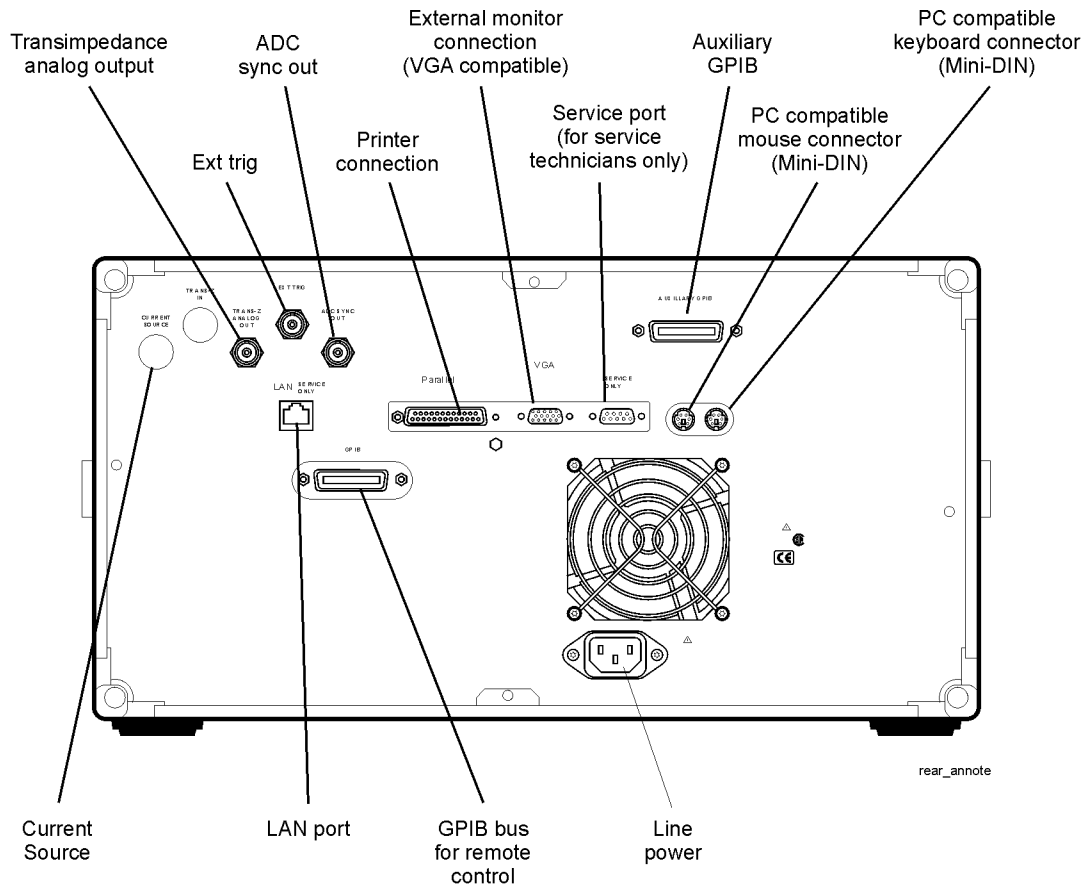

Optical Spectrum Analyzer Display

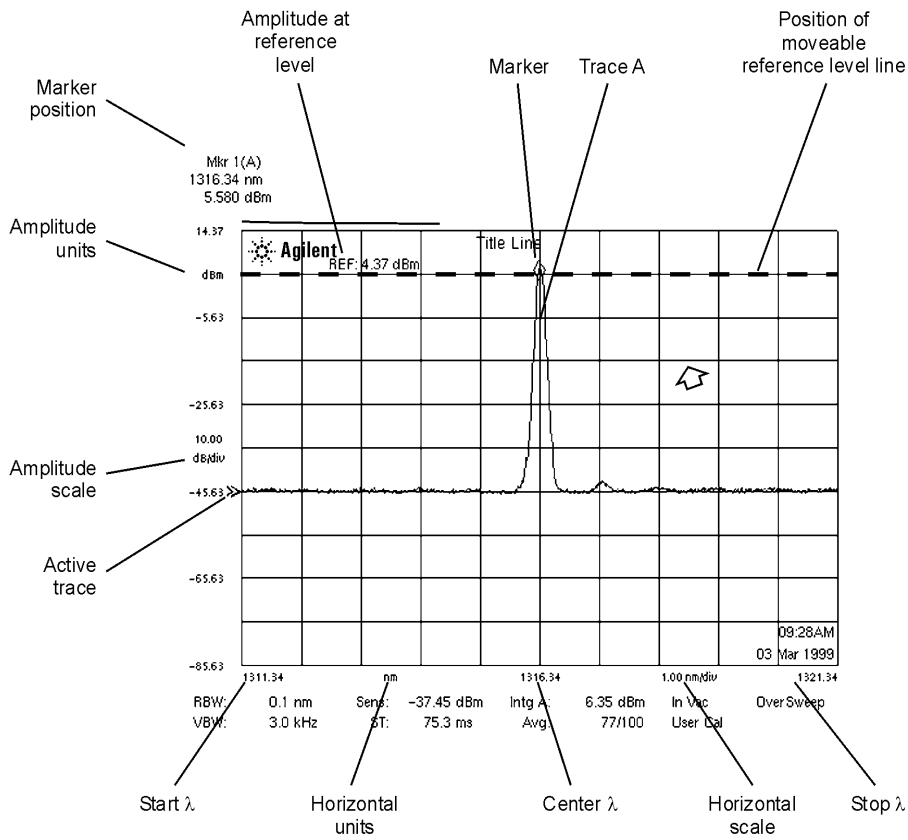

Figure 1-1. Optical Spectrum Analyzer Display

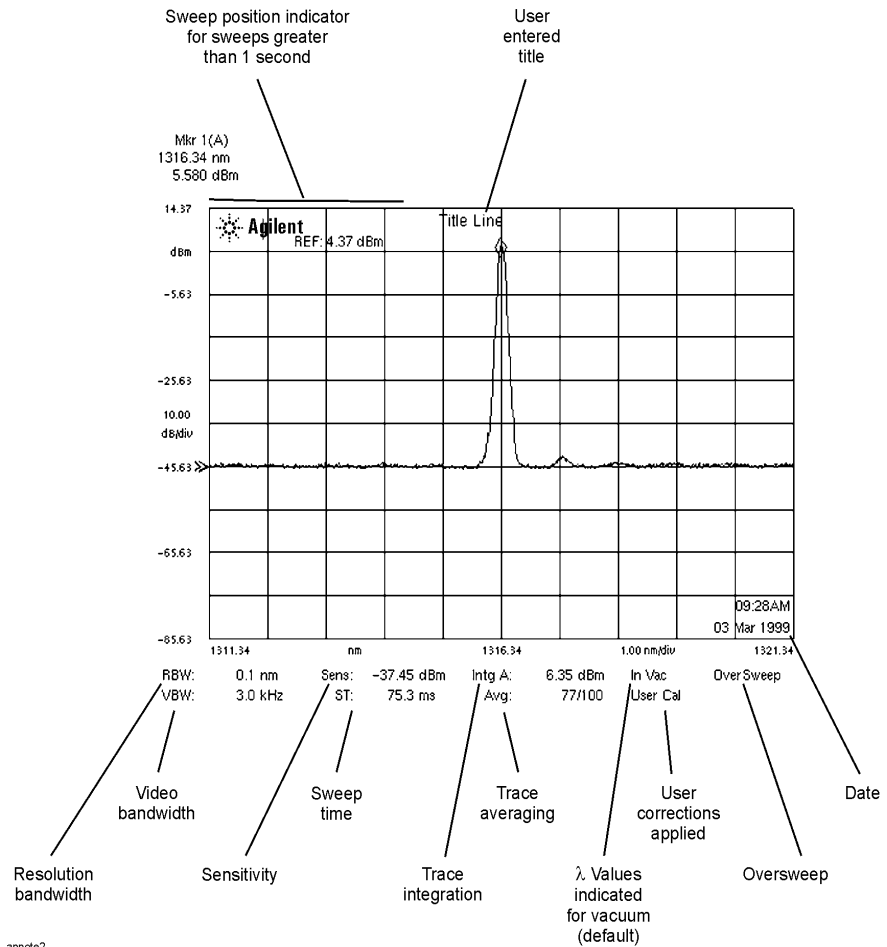

Figure 1-2. Display Annotations

Setting Up the Analyzer

Step 1. Receive and Inspect the Shipment

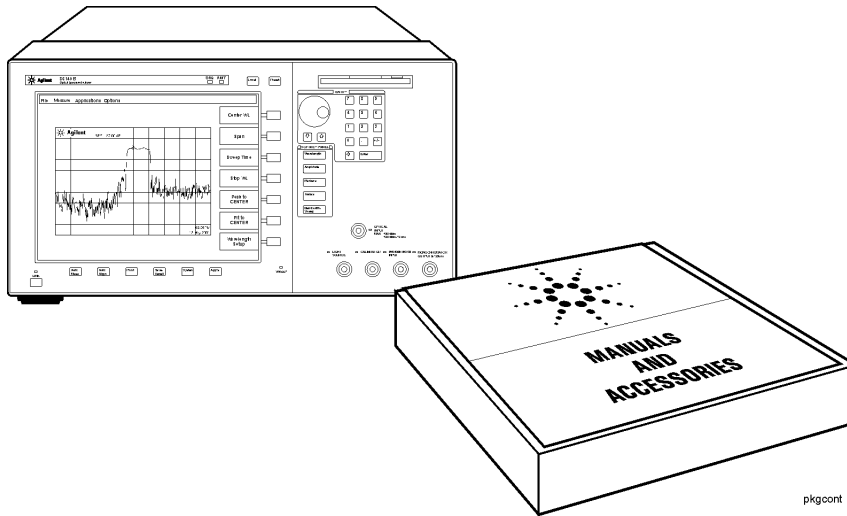

Table 1-1. Items in a Standard Agilent 8614xB Series Shipment

Description	Product Number	Item Quantity
BNC Cable (24 inches)	8120-1839	1
GPIB Cable	8120-3444	1
FC/PC Dust Cap	1401-0291	2
English User's Guide Manual	86140-90U03	1
Application Guide	86140-90071	1
Programming Guide	86140-90069	1

- Inspect the shipping container for damage.
- Inspect the instrument.
- Verify that you received the options and accessories you ordered.

Keep the shipping container and cushioning material until you have inspected the contents of the shipment for completeness and have checked the optical spectrum analyzer mechanically and electrically.

If anything is missing or defective, contact your nearest Agilent Technologies Sales Office. Refer to "Returning the Instrument for Service" on page 6-21. If the shipment was damaged, contact the carrier, then contact the nearest Agilent Technologies Sales Office. Keep the shipping materials for the carrier's inspection. The Agilent Technologies Sales Office will arrange for repair or replacement at Agilent Technologies' option without waiting for claim settlement.

Step 2. Connect Accessories and Power Cord

- Although you can operate all instrument functions using only the front-panel keys, and track-ball on portable models, these accessories make your optical spectrum analyzer easier to use. Connect any standard PC-compatible mouse (or other pointing device), keyboard, or external VGA-compatible display.

Getting Started
Setting Up the Analyzer

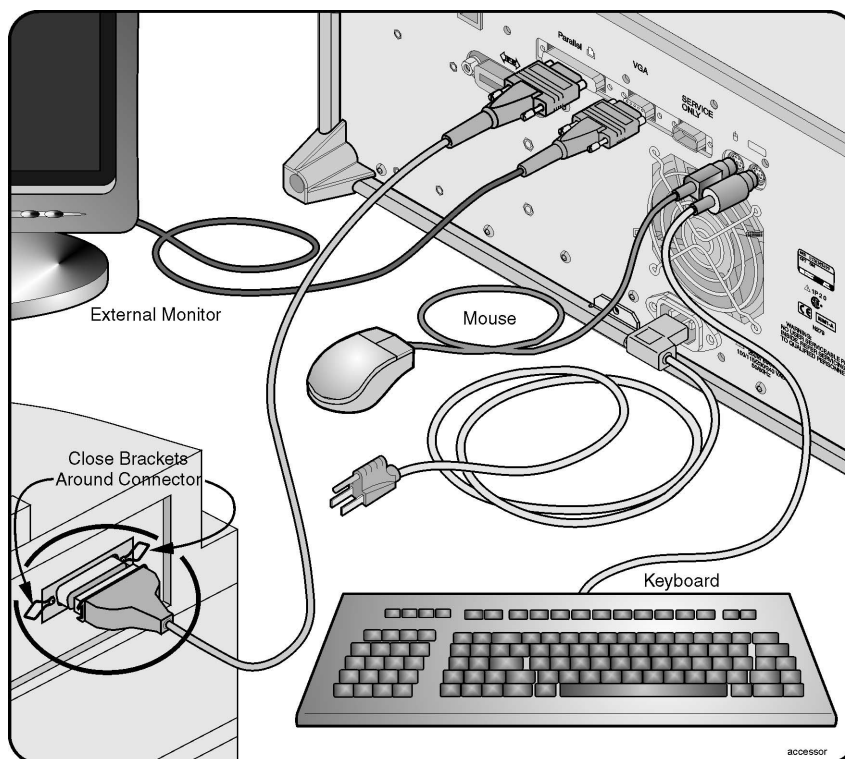

CAUTION

Do *not* stack other objects on the keyboard; this will cause self-test failures on power-on.

- r You can connect a PCL-language printer (for example, an HP¹ LaserJet) to the instrument's rear panel Parallel connector. Use a parallel Centronics printer cable, such as an HP C2950A (2 m) or HP C2951A (3 m).
- r The line cord provided is matched by Agilent Technologies to the country of origin on the order. Refer to "Accessories" on page 1-28.

Table 1-2. Line Power Requirements

Voltage	100/ 115/ 230/ 240 V ~
Frequency	50 / 60 Hz

1. HP and Hewlett-Packard are U.S. registered trademarks of Hewlett-Packard Company.

Step 3. Apply Power to Instrument

- Press the power switch at the lower left-hand corner of the front panel.
- After a short initialization period, the display will look similar to the picture on this page.
- Allow the instrument to warm up for at least 1 hour.

Step 4. Clean Connectors and Prepare for Measurements

CAUTION

Fiber-optic connectors are easily damaged when connected to dirty or damaged cables and accessories. The front-panel INPUT connector of the Agilent 8614x series is no exception. When you use improper cleaning and handling techniques, you risk expensive instrument repairs, damaged cables, and compromised measurements. Before you connect any fiber-optic cable to the Agilent 8614x series optical spectrum analyzer, refer to "Cleaning Connections for Accurate Measurements" on page 6-8.

CAUTION

A front-panel connector saver is provided with Agilent 8614x series instruments. Attach the connector saver to the front-panel INPUT connector of the instrument. You can now make your connections to the connector saver instead of the instrument. This will help prevent damage to the front-panel INPUT connector of the instrument. Damage to the front-panel INPUT connector is expensive in terms of both repair costs and down-time. Use the front-panel connector saver to prevent damage to the front-panel INPUT connector.

Note

All product specifications apply to measurements made *without* using the front-panel connector saver.

- After the instrument has warmed up for at least 1 hour, perform an auto align by pressing the front panel Auto Align button. This will ensure optimal amplitude accuracy, and can correct for any mis-alignment caused by the instrument shipment.

To learn more about this or any Agilent Technologies Optical Test and Measurement Products, visit our web site at

<http://www.agilent.com/comms/optical>

Making a Measurement

This procedure will introduce you to the Agilent 8614x series optical spectrum analyzer front panel controls. By following this procedure you will do the following:

- Perform an auto alignment
- Perform a peak search
- Use a delta marker
- Print the display

Refer to "The Menu Bar" on page 1-15 and "The Softkey Panels" on page 1-16.

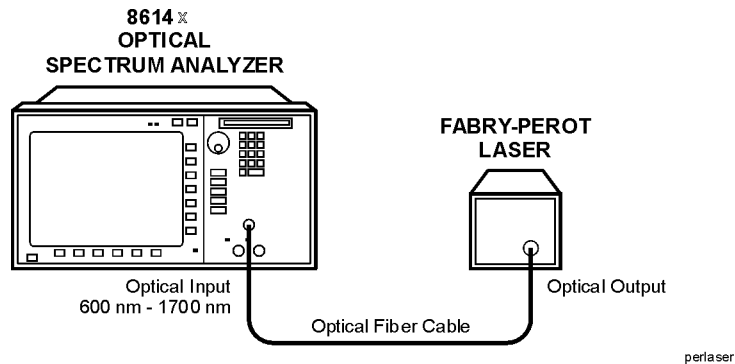

Instrument setup

A source signal must be present at the input of the optical spectrum analyzer. In this procedure a Fabry-Perot laser is used as the source. You can use another source or the optional 1310/1550 nm module. If another source is being used, the display will differ from those shown.

To set the OSA to a known state

- Press the front-panel Preset key to set the instrument to a known state. For a complete description of preset conditions, see page 3-59.

To perform an Auto Align

For maximum amplitude accuracy, perform an automatic alignment whenever the optical spectrum analyzer has been moved, subjected to large temperature changes, or following warm-up. See "Auto Align" on page 3-9 for more information.

- 1 Connect a fiber from the source to the input connector of the optical spectrum analyzer. Be sure to follow the good connector practices described in "Cleaning Connections for Accurate Measurements" on page 6-8.
- 2 Enable the source. Press Markers > *Peak Search* to find the peak signal power.
- 3 Press the front-panel Auto Align key to optimize the detection of the incoming signal. This takes a few moments to complete.

To perform a peak search

- 4 Press the front-panel Auto Meas key to locate and zoom-in on the signal. Please wait until the Auto Measure routine is complete. A marker is placed on the peak of the displayed signal.

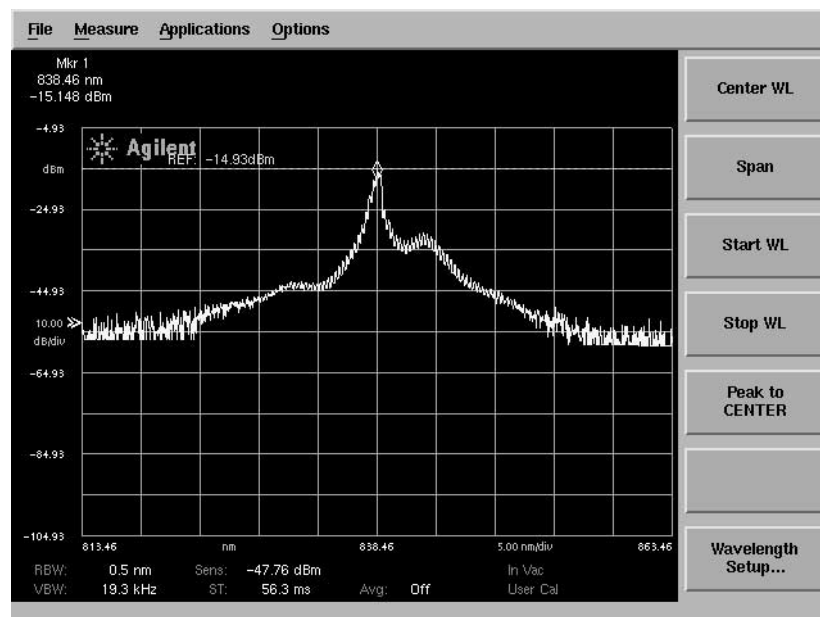

Trace with normal marker.

To zoom in on the signal

Press the *Span* softkey and then use the knob, step keys, or numeric keypad to zoom in on the signal.

Getting Started
Making a Measurement

Using the delta marker

The optical spectrum analyzer has four types of markers; normal markers, bandwidth markers, delta markers and noise markers. The marker currently being displayed is a normal marker. In the next step we will use it as a delta marker.

- 5 Press the front-panel Markers key.
- 6 Press the *More Marker Functions...* softkey.
- 7 Press the *Delta Marker* softkey to activate the delta marker and the active function area.
- 8 Use the knob, step keys or numeric entry pad to move the delta marker.
- 9 The reference marker remains stationary.

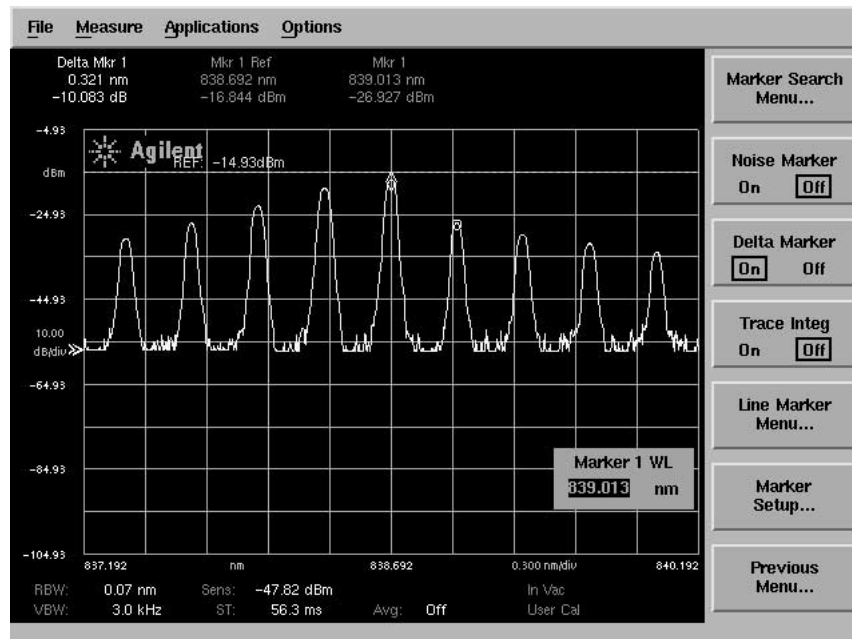

Trace with delta marker.

Printing the display

- 10 Press the Print key to print a copy of the display. The output will be sent to the internal or external printer, depending on the printer selected.

The Menu Bar

The Menu bar includes the File, Measure, Application, and Options drop-down menus. Each menu selection includes a descriptive label.

(Action) Indicates the selection will perform an action such as making a measurement or printing the display.

(Panel) Indicates the selection will open a softkey panel.

The File Menu

<u>1</u> Save/Recall... (Panel)
<u>2</u> Print (Action)
<u>3</u> Printer Setup...
<u>4</u> Local (Action)
<u>5</u> Preset (Action)

The Measure Menu

<u>1</u> Wavelength... (Panel)
<u>2</u> Amplitude... (Panel)
<u>3</u> Markers... (Panel)
<u>4</u> Traces... (Panel)
<u>5</u> Bandwidth/Sweep... (Panel)
<u>6</u> Auto Measure (Action)
<u>7</u> Auto Align (Action)

The Applications Menu

<u>F</u> ile <u>M</u> easure <u>A</u> pplications <u>O</u> ptions
<u>1</u> Launch an Installed Application... (Panel)

The Options Menu

<u>F</u> ile <u>M</u> easure <u>A</u> pplications <u>O</u> ptions
<u>1</u> System Menu... (Panel)

The Softkey Panels

You can access the softkey panels using either the front-panel keys or the menu bar. This section includes brief descriptions of the following menus. See Chapter 3, "Function Reference" for additional information on each of the OSA functions.

- The Amplitude Menu 1-17
- The Applications Menu 1-17
- The Bandwidth/Sweep Menu 1-19
- The Markers Menu 1-20
- The Save/Recall Menu 1-21
- The Systems Menu 1-22
- The Traces Menu 1-24
- The Wavelength Menu 1-25

The Amplitude Menu

You can access the Amplitude softkeys using the front-panel Amplitude key or the Measure menu Amplitude selection on the menu bar.

The Amplitude menu

1	Wavelength...	(Panel)
2	Amplitude...	(Panel)
3	Markers...	(Panel)
4	Traces...	(Panel)
5	Bandwidth/Sweep...	(Panel)
6	Auto Measure	(Action)
7	Auto Align	(Action)

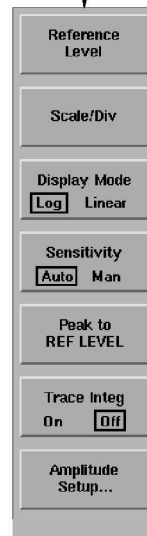

Amplitude Setup		
Reference Level Position:	9.0	Divisions
Amplitude Units:	<input checked="" type="checkbox"/> Auto	<input type="checkbox"/> W
Auto Ranging:	<input checked="" type="checkbox"/> On	<input type="checkbox"/> Off
Auto Zero:	<input checked="" type="checkbox"/> On	<input type="checkbox"/> Off
Auto Chop Mode:	<input type="checkbox"/> On	<input checked="" type="checkbox"/> Off
Power Calibration:	<input type="checkbox"/> User	<input checked="" type="checkbox"/> Factory
User Power Cal Date:	No User Cal	
Amplitude Correction Sel:	<input checked="" type="checkbox"/> 1	<input type="checkbox"/> 2 <input type="checkbox"/> 3 <input type="checkbox"/> 4
Amplitude Correction Mode:	<input checked="" type="checkbox"/> On	<input type="checkbox"/> Off

The Applications Menu

You can access the Applications (App'l's) softkeys by using the front-panel App'l's key or the Applications menu Launch an Installed Application section on the menu bar. For a complete description of the applications, refer to the Agilent 8614xB Series Measurement Applications User's Guide that came with your instrument.

Getting Started
The Softkey Panels

The Applications menu

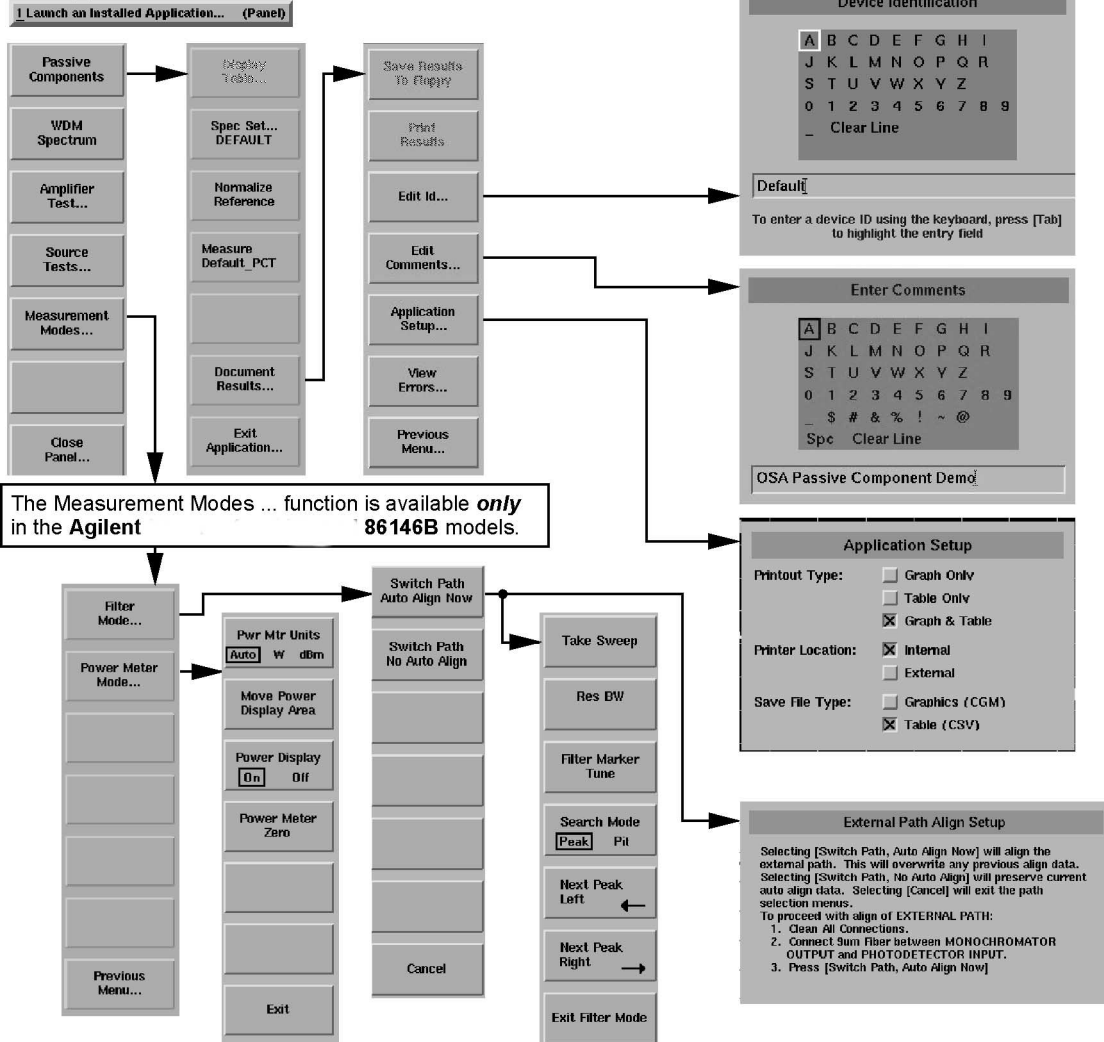

The Bandwidth/Sweep Menus

You can access the Bandwidth/Sweep softkeys by using the front-panel Bandwidth/Sweep key or the Measure menu Bandwidth/Sweep selection on the menu bar.

The Bandwidth/Sweep menu

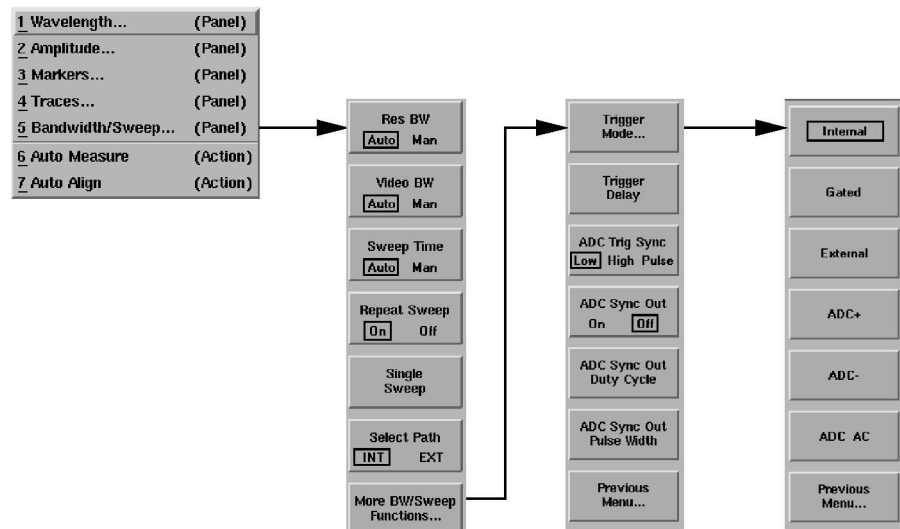

The Markers Menus

You can access the Markers softkeys by using the front-panel Markers key or the Measure menu Markers selection on the menu bar.

The Markers menu

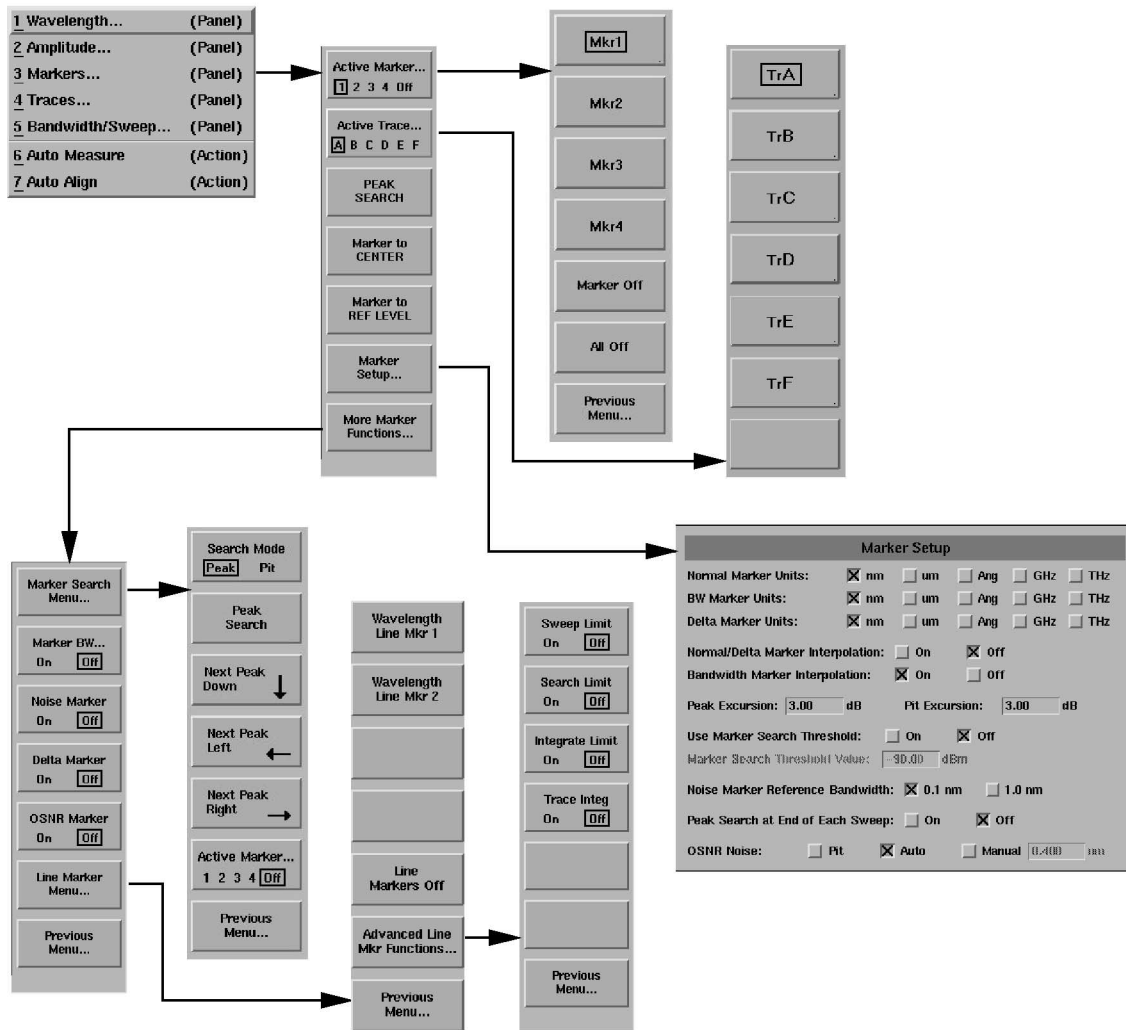

The Save/Recall Menus

You can access the Save/Recall softkeys and setup panels by using the drop-down File menu Save/Recall selection or the front-panel Save/Recall key. Use these functions to save, recall and print the measurement results.

The Save/Recall menu

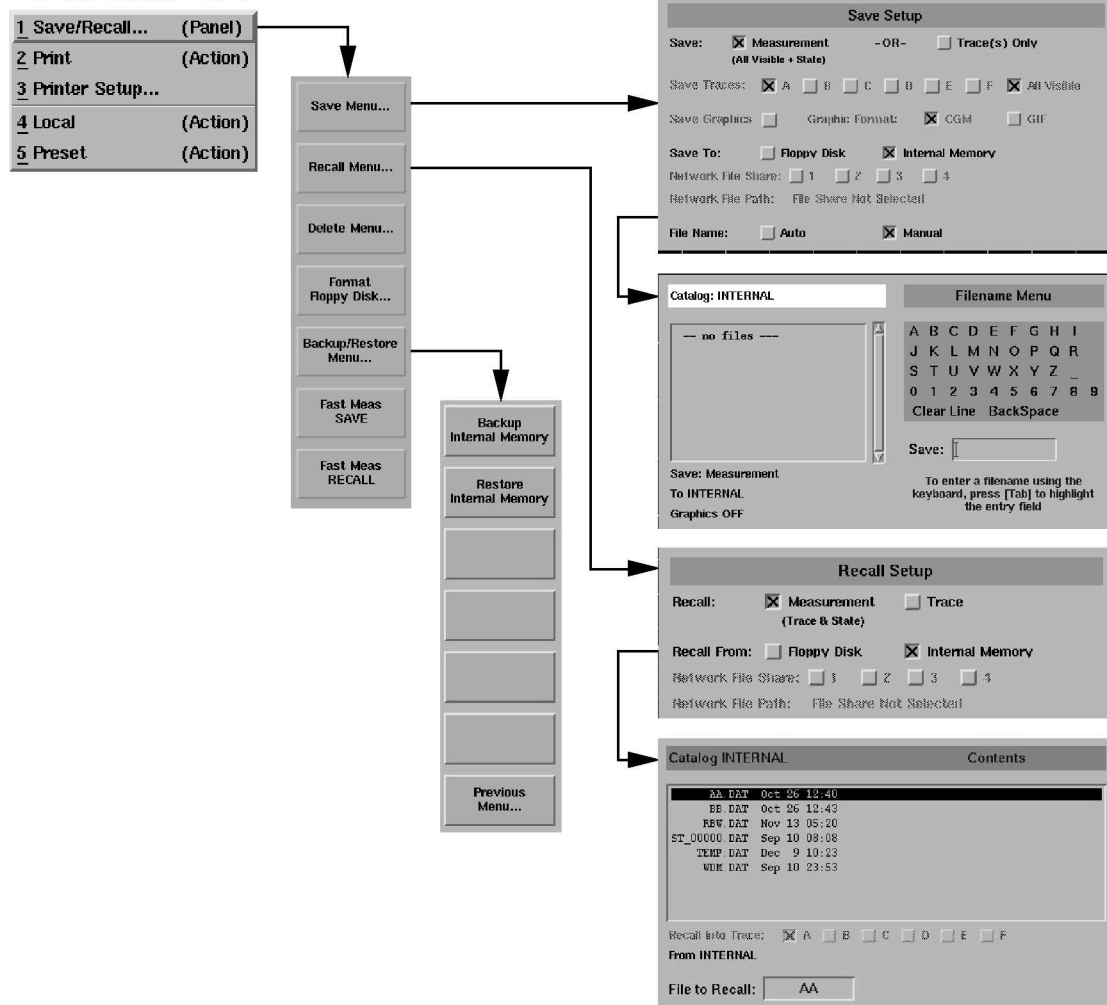

The Systems Menus

You can access the System softkeys by using the front-panel System key or the Options menu System selection on the menu bar.

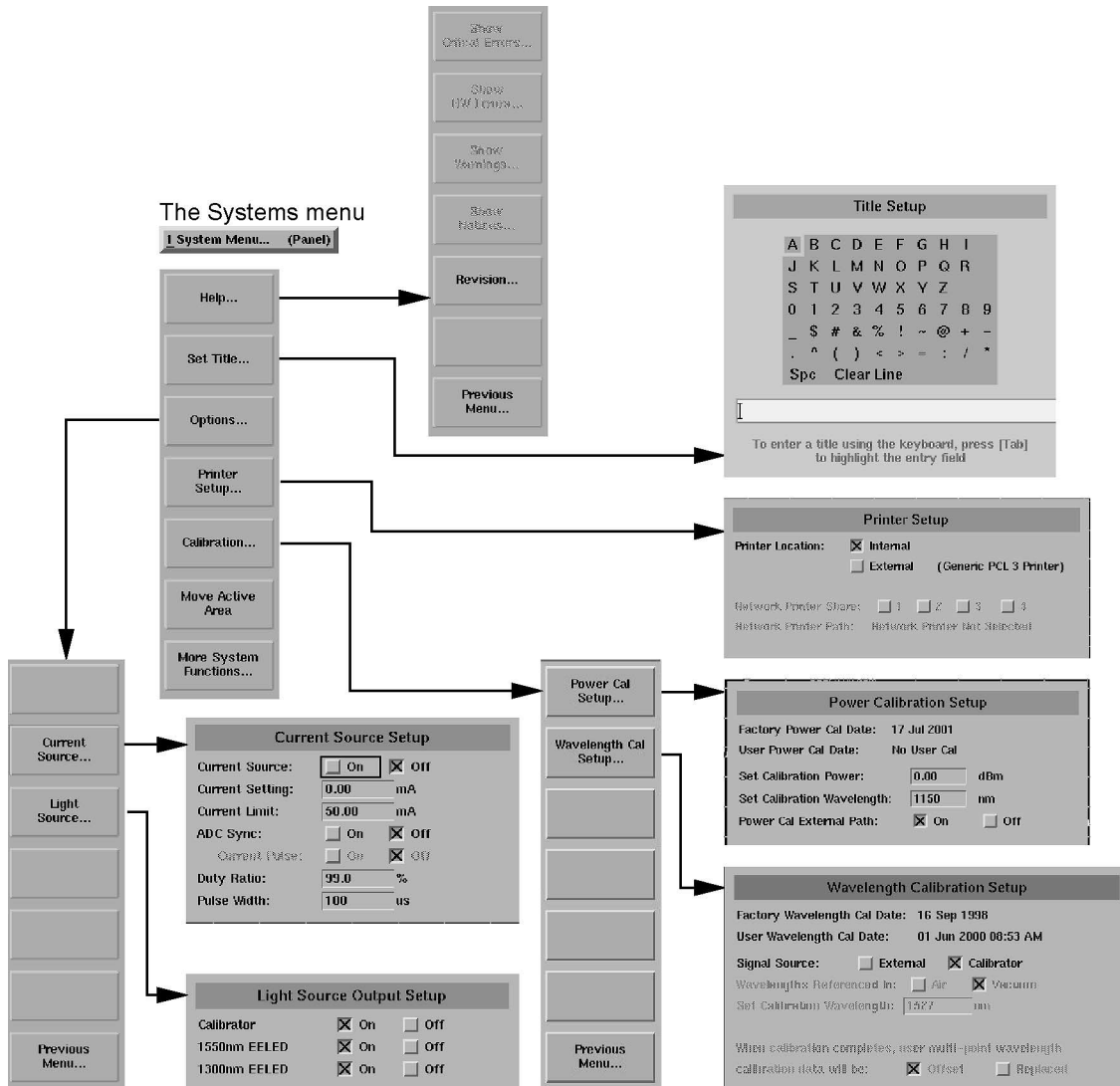

The Systems Menus, continued....

The Systems menu

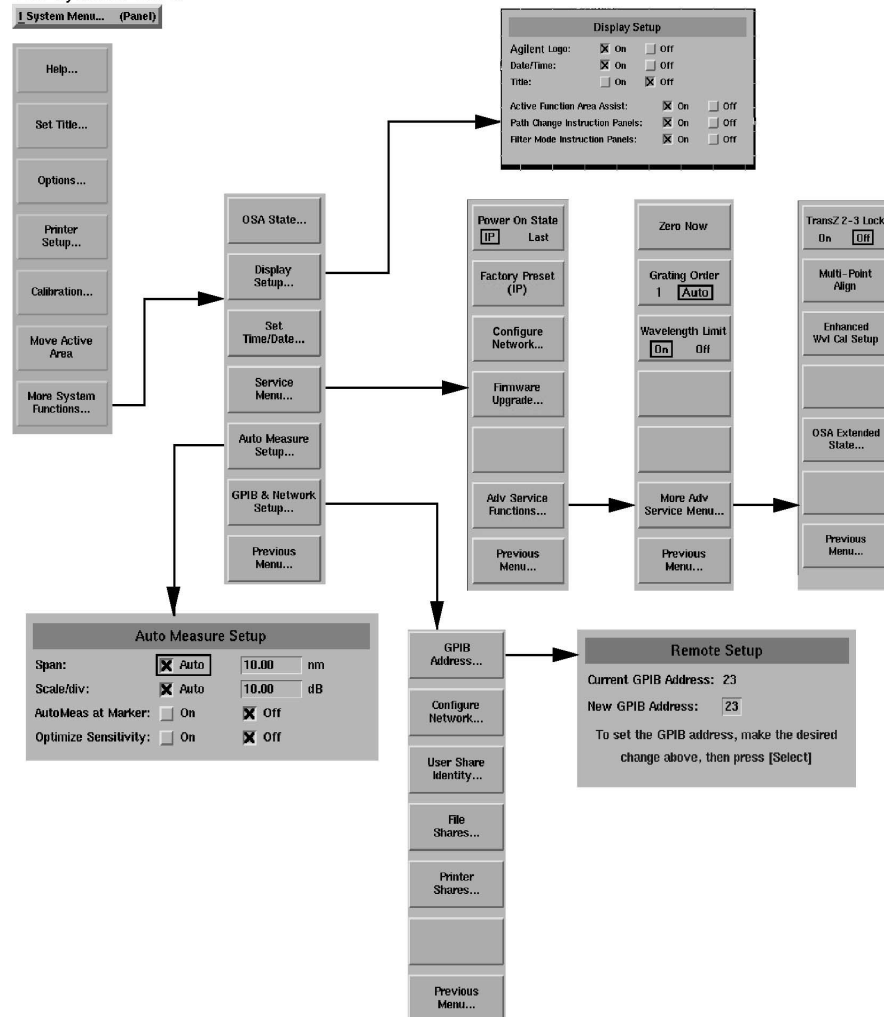

The Traces Menus

You can access the Traces softkeys by using the front-panel Traces key or the Measure menu Traces selection on the menu bar.

The Traces menu

1 Wavelength...	(Panel)
2 Amplitude...	(Panel)
3 Markers...	(Panel)
4 Traces...	(Panel)
5 Bandwidth/Sweep...	(Panel)
6 Auto Measure	(Action)
7 Auto Align	(Action)

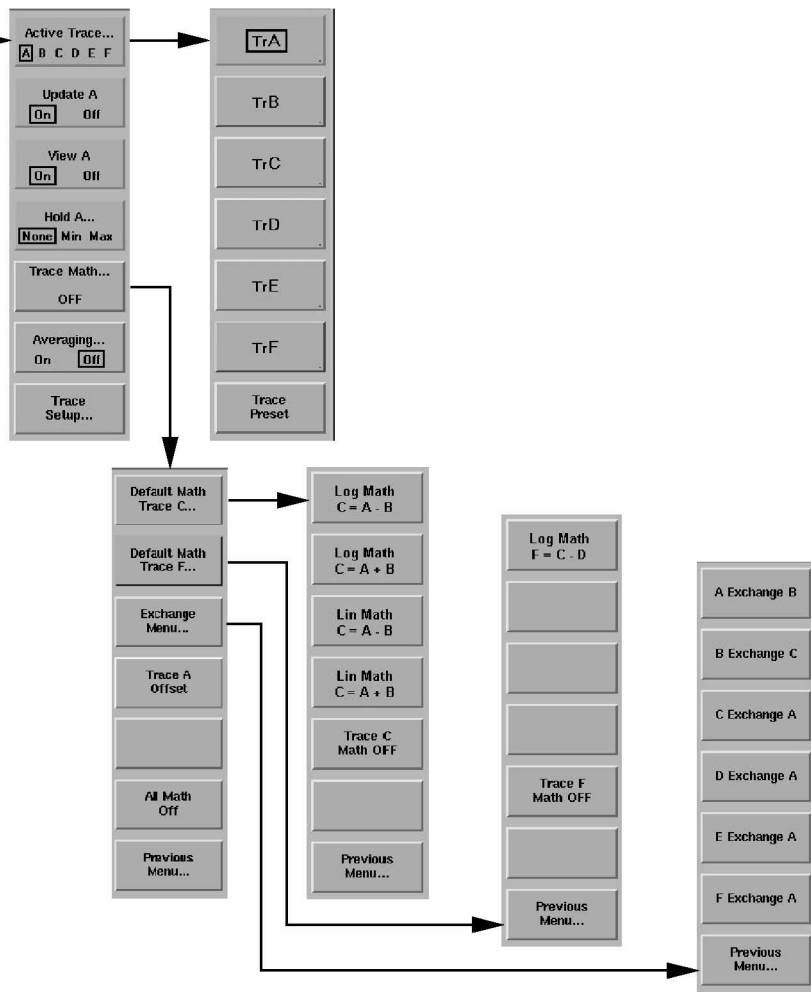

The Wavelength Menu

You can access the Wavelength softkeys by using the front-panel Wavelength key or the Measure menu Wavelength selection on the menu bar.

The Wavelength menu

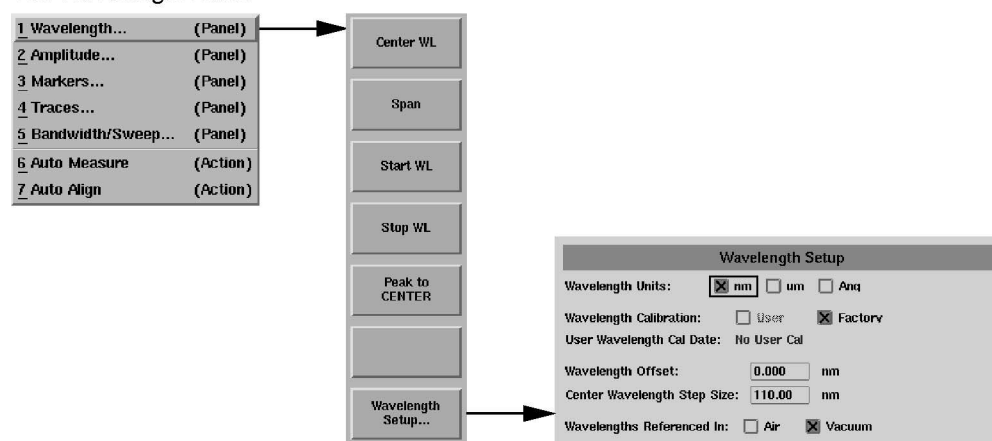

Laser Safety Information

- Laser Safety Information

The light sources specified by this user guide are classified according to IEC 60825-1 (2001). The light sources comply with 21 CFR 1040.10 except for deviations pursuant to Laser Notice No. 50, dated 2001-July-26

Laser type	Edge emitting LED (EELED)	
Wavelength	1310nm	1550 nm
Max. CW output power *	50 μ W	
Beam waist diameter	9 μ m	
Numerical aperture	0.1	
Laser class according to IEC 60825-1 (2001)	1	
Max. permissible CW output power **	15,6mW	10mW
* Max. CW output power means the highest possible optical CW power that the laser source can produce at its output.		
** Max. permissible CW output power is the highest optical power that is permitted within the appropriate IEC laser class.		

WARNING - Please pay attention to the following laser safety warnings:

- Under no circumstances look into the end of an optical cable attached to the optical output when the device is operational. The laser radiation can seriously damage your eyesight.
- Do not enable the laser when there is no fiber attached to the optical output connector.
- The use of optical instruments with this product will increase eye hazard.
- Refer servicing only to qualified and authorized personnel.

Product Options and Accessories

Options	Agilent 86142B, 86146B Benchtop	Agilent 86143B, 86145B Portable
Instrument System Options		
Current Source	Opt. 001	----
White Light Source	Opt. 002	----
Built-in 1310 & 1550 nm EELED Source	Opt. 004	----
Built-in 1550 nm EELED Source	Opt. 005	----
Wavelength Calibrator	Opt. 006	Opt. 006
Time Resolved Chirp Application	Opt. DPC ^a	Not Applicable
DWDM Spectral Analysis Application	Included	Included
Passive Component Test Application	Included	Included
Amplifier Test Application	Included	Included
Source Test Application	Included	Included
Alternative Connector Interface		
FC/PC	Standard	Standard
DIN	Opt. 013	Opt. 013
ST	Opt. 014	Opt. 014
SC	Opt. 017	Opt. 017
Multimode Fiber Input ^b		Opt. 025 (Agilent 86143B)
Certificate of Calibration	Included	Included

a. Option available for 86146B only.

b. 50µm multimode input available on Agilent 86143B OSA's only.

Getting Started
Product Options and Accessories

Table 1-3. Accessories

Option	Description	Product Number	Item Quantity
Connector Accessories			
012	FC/PC Connector Adapter	08154-61702	3
	FC/PC Dust Cap	1401-0291	3
	Angled to Flat, FC/PC Adapter	1250-3175	1
013	DIN Optical Connector Adapter	08154-61703	3
	DIN Dust Cap	1401-0291	3
014	ST Optical Connector Adapter	08154-61704	3
	ST Dust Cap	1401-0291	3
017	SC Optical Connector Adapter	08154-61708	3
	SC Dust Cap	1401-0291	3
Power Selection			
900	Power Cord (United Kingdom)	8120-1351	1
901	Power Cord (Australia, New Zealand, China)	8120-1369	1
902	Power Cord (Europe)	8120-1689	1
903	Power Cord (United States)	8120-1378	1
906	Power Cord (Switzerland)	8120-2104	1
912	Power Cord (Denmark)	8120-3997	1
917	Power Cord (South Africa, India)	8120-4211	1
918	Power Cord (Japan)	8120-4753	1
919	Power Cord (Israel)	8120-5182	1
920	Power Cord (Argentina)	8120-6868	1
921	Power Cord Chilean)(8120-6979	1
922	Power Cord (China)	8120-8376	1
Documentation and Manuals			
ABC	Traditional Chinese User's Guide	86140-90067	1
	Traditional Chinese Application Guide	86140-90066	
Certification of Calibration and Service			
1BM	Standard Commercial Calibration Certificate	N/A	1
UK6	Commercial Calibration Certificate with Test Data	N/A	1
W30	Extended Warranty to 3 Years Return for Service	N/A	1

Table 1-4. Available Fiber Sizes

Model Number	Optical Input	Option 002 ^a (White Light Source)	Option 004a (1310/1550 EELED)	Option 005a (1550 EELED)	Option 006 (Calibrator)	Photo-diode Input	Mono Output 1
86143B	9 μm	N/A	N/A	N/A	9 μm	N/A	N/A
Opt 025	50 μm				9 μm		
86145B	9 μm	N/A	N/A	N/A	9 μm	N/A	N/A
86142B	9 μm	62,5 μm	9 μm	9 μm	9 μm	N/A	N/A
86146B	9 μm	62,5 μm	9 μm	9 μm	9 μm	50 μm	9 μm

a. Options 002, 004, and 005 are exclusive





Getting Started
 Product Options and Accessories

Table 1-5. Additional Parts and Accessories

	Agilent Benchtop OSA 86142B, 86146B	Agilent Portable OSA 86143B, 86145B
Printer Paper (5 rolls/box)	9270-1370	9270-1370
Additional Connector Interfaces	See Agilent 81000 series	See Agilent 81000 series
External 10 dB Attenuator (FC/PC)	Opt. 030	Opt. 030
Rack-Mount Flange Kit	Opt. AX4	N/A
Transit Case	9211-2657	9211-5604
Soft Carrying Case	N/A	Opt. 042
BenchLink Lightwave Software ^a	Standard	Standard

a. Agilent N1031A BenchLink Lightwave allows transfer of measurement results over a GPIB Interface to a PC for the purposes of archiving, printing, and further analysis.

Front Panel Fiber-Optic Adapters

Front Panel Fiber-Optic Adapter	Description	Agilent Part Number
	FC/PC ^a	08154-61702
	SC	08154-61708
	DIN	08154-61703
	ST	08154-61704

a. The FC/PC is the default front-panel optical connector.

Getting Started
Product Options and Accessories

Setting Up Measurements 2-2
Calibrating Wavelength Measurements 2-13
Saving, Recalling, and Managing Files 2-18
Analyzing Measurement Data 2-26
Analyzer Operating Modes 2-29

Setting Up Measurements

This section contains the following information that will help you set up a wavelength measurement:

- Adjusting Setup Conditions
- Operating the Internal White Light Source
- Averaging Traces
- Setting Video Bandwidth
- Using Span to Zoom In
- Setting the Sensitivity
- Triggering a Measurement
- Moving the Active Function Area
- Indicating an Update is Needed

Adjusting Setup Conditions

Setup panels allow you to adjust setup conditions which are not frequently changed. Refer to "Preset" on page 3-59.

Using the softkeys

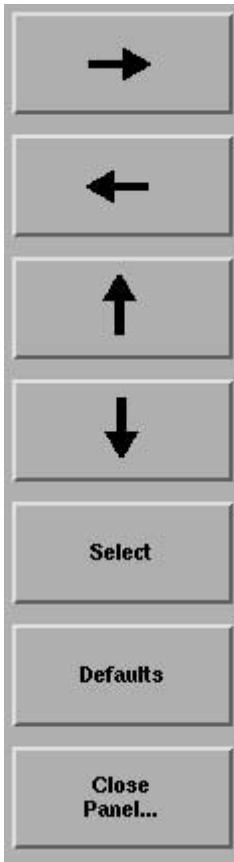

Arrows allow you to navigate from field to field in the dialog box. The highlighted parameter can be changed. The front-panel number keys, step keys, and knob allows the user to enter a numeric value in the highlighted field.

Select selects the highlighted parameter. You can enter values for a selected parameter using the front panel knob or numeric entry pad.

Defaults resets the parameters to their default condition.

Close Panel saves the current setup and returns you to the previous menu.

Operating the Internal White Light Source

For Option 002 only

Option 002 provides a built-in white light source which is a stable, broadband light source for swept-wavelength stimulus response testing from 900 nm to 1700 nm. The light source is ideal to perform stimulus-response measurements, and measure photodetector responsivity. Refer to "Light Source" on page 3-29.

Note

Although the light source's lamp lasts an exceptionally long time, turn off the light when not in use to extend the lamp's lifetime. On the front panel, press System, Optimum, Light Source, Select off.

- 1 From the front panel, press System > Options > Light Source > Select Off.

Performing Stimulus-Response Measurements

Stimulus-response measurements characterize optical components for loss (or gain) versus wavelength. You can characterize devices such as couplers, switches, filters, fibers, and amplifiers.

To perform stimulus-response measurements, you must have an amplitude-stable broadband light source. Although a white-light source provides the widest wavelength input for stimulus-response measurements, you can also use an LED or the spontaneous emission from an optical amplifier.

The displayed response is a convolution of the analyzer's resolution bandwidth and the amplitude response of the device under test. Because of this convolution, the analyzer's resolution bandwidth affects both dynamic range and the ability to resolve large amplitude changes versus wavelength. Wide resolution bandwidths increase the ability to resolve large amplitude changes.

You can display two responses at the same time. The output response versus wavelength is displayed. The displayed trace shows the ratio of the output power to the input power expressed as a logarithm (dB).

$$\text{response (dB)} = 10 \log(\text{output power}/\text{input power})$$

Making ratioed measurements is sometimes referred to as normalization. Normalized measurements are used to negate wavelength dependencies in the source. The ratio is achieved through simple trace subtraction using logarithmic amplitude scales. This is possible because of the following logarithmic equality:

$$\log(A/B) = (\log A - \log B)$$

- 1 Connect the Light Source Output to the Monochromator Input using the short 62.5/125 μm fiber. The standard connector interface is FC/PC.

Averaging Traces

Trace averaging improves your measurement repeatability by smoothing out noise. For measurements involving slow polarization scrambling, using video filtering to improve repeatability will require a very narrow video bandwidth (less than 10 Hz). This would result in a long measurement time, where trace averaging would be faster. Refer to "Averaging" on page 3-13.

- 1 From the front panel, press Traces > Averaging.
- 2 Toggle to select the Averaging on or off.
- 3 Select from the 10, 20, 50 or 100 softkeys or use the knob, step keys, or numeric entry pad to enter the desired average count.

Note

For measurements with fast polarization scrambling, video filtering (adjusting video bandwidth) is generally faster than trace averaging for similar repeatability requirement.

Setting Video Bandwidth

Video bandwidth filtering occurs after the detection of the light. In the auto coupled mode, the video bandwidth has an extremely wide range. This allows the instrument to avoid unnecessary filtering that would reduce the sweep speed more than required. Refer to "Video BW" on page 3-91.

The instrument has two detection techniques: peak (auto mode) and sample (manual mode). Peak detection is beneficial for maintaining the fastest sweep times and displaying narrow aspect ratio signals. Sample detection is beneficial for obtaining best measurement accuracy and measuring low level signals.

Peak detection finds and displays the maximum signal level present during each trace point interval. Peak detection is used if video filtering is not required to achieve the desired level of sensitivity. However, there is one exception: if an auto-coupled sweep time is limited by either maximum motor speed or a 50 ms auto-coupling limit, then sample detection is used with as narrow a digital video bandwidth as possible in order to achieve maximum sensitivity for the chosen sweep time. This exception only applies when both sweep time and video bandwidth are auto-coupled.

Sample detection displays a filtered version of the sampled data at the end of each trace point interval. The filter function is varied with the video bandwidth function from 100 mHz to 3.0 kHz, or the bandwidth of the currently selected transimpedance amplifier, whichever is less. Increased filtering provides greater sensitivity.

The detection mode is automatically determined by the instrument. You can adjust the settings of video bandwidth, sensitivity, or sweep time to obtain the desired detection mode. Sample detection can be forced at any time by putting video bandwidth in manual. Peak detection can usually be obtained by placing sensitivity and video bandwidth in auto.

The following functions affect video bandwidth:

- changing the sensitivity value
- changing the reference level
- turning auto ranging on or off

The range of video bandwidths available in auto mode is much greater than can be set manually from the front panel. A lower video bandwidth value requires a longer sweep time. Because of the interdependence between the video bandwidth and sensitivity, it is recommended that either the sensitivity or the video bandwidth be changed, whichever is the most important to the measurement task being performed.

To reduce noise, you can select a narrower video bandwidth to improve repeatability and sensitivity or select a wider video bandwidth to shorten overall measurement time. This selection allows the choice between repeatability and measurement time based on your measurement requirements. The narrower the video bandwidth, the longer the sweep time.

- 1 From the front panel, press Bandwidth/Sweep > Video BW.
- 2 Toggle to select the video bandwidth automatically or manually.
- 3 Use the knob, step keys, or numeric entry pad to enter the desired value.

Note

For measurements with slow polarization scrambling, use trace averaging to improve measurement repeatability. Trace averaging is faster than video filtering for the slow polarization scrambling application.

Using Span to Zoom In

To see a more detailed view of the device's response, decrease the wavelength span to expand the trace. This will enable you to precisely focus in on the desired measurement area. Refer to "Span" on page 3-79.

Press Wavelength > *Span* and reduce the span by entering the value of 2 nm.

Setting the Sensitivity

Setting sensitivity requests the lowest amplitude signal that can be measured relative to the highest amplitude signal displayed. It is defined as the signal that is six times the RMS noise. The minimum setting is -100 dB. An error will be reported for values outside of this range and the sensitivity will round to the nearest valid sensitivity. Refer to "Sensitivity" on page 3-74.

Manual allows manual input of sensitivities and enables auto gain ranging. The "top of screen" and the sensitivity setting determines the requested dynamic range. The system will sweep once per gain stage and may require up to three sweeps to achieve the requested dynamic range.

Auto automatically chooses a sensitivity and a single gain range based on "top of screen". This will result in approximately 40 dB of dynamic range.

The sweep time that is displayed in the lower portion of the display is the time for the OSA to sweep over one gain stage. The OSA may take up to three sweeps in three different gain stages to make the measurement. This depends on the settings for sensitivity, reference level, auto range and also the particular device being measured. The final data trace is a blended composite of each trace taken in the different gain stages.

An increase in sensitivity may also require a narrower video bandwidth, which will slow the sweep speed. Normally, the optical spectrum analyzer selects the greatest sensitivity possible that does not require amplification changes during the sweep. If you manually increase the sensitivity level, the sweep pauses to allow this change in gain.

The settings for sensitivity, video bandwidth and sweep time interact. If the sensitivity is set to manual, the video bandwidth and sweep time may be forced to Auto mode. If the video bandwidth is set to manual, the sensitivity and sweep time may be forced to Auto. If the sweep speed is set to manual and is set too fast, the over sweep indicator will come on in the display area. Since these settings interact, it is recommended that only one of the settings be changed, whichever setting is most important to the measurement task being performed.

Press Amplitude, Sensitivity, toggle to manual, and enter a value.

Triggering a Measurement

Triggering a measurement synchronizes the start of the sweep to an internally generated trigger signal. Internal triggering ensures continuously triggered sweeps with the shortest delay between sweeps. Refer to "Trigger Mode, Internal" on page 3-88.

In some measurements, the spectrum at a particular time within the modulation period is more important than the average spectrum. Gated triggering can be used to synchronize the data acquisition portion of the OSA to a gating trigger connected to the rear-panel EXT TRIG IN connector. Gated triggering requires a TTL-compatible signal with a minimum of 0 Vdc and a maximum of +5 V.

Gated triggering ignores the spectrum when the trigger input is low. It usually is used in conjunction with the Max Hold function during several sweeps.

Gated Sweep Mode

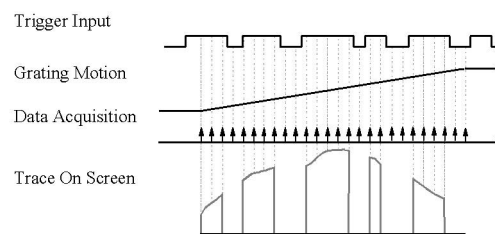

Gated triggering is used to select data samples containing valid information. When the gating signal is high, the data sample is accepted. When the gating signal is low, the data sample is replaced by a data point with a value of -200 dBm. Processing continues according to the functions selected, such as, video bandwidth, max hold, and so forth.

If the low level exists for longer than the time needed for the grating to move from one trace point to the next, then the trace will have "gaps". There are two ways to eliminate the gaps. You can increase the sweep time to at least:

$(1.2-2 \text{ times the product trace length}) \times (\text{the longest "low level" period})$

Using the Instrument
Setting Up Measurements

The display will have at least one data sample marked as valid (high level) per trace point. Or else you can use the Max Hold function to complete a trace over several sweeps. Multiple sweeps fill the gaps because the high and low levels of the gating signal occur independent of the grating position.

Gated triggering has no time limit for the high or low level. It can be used to characterize pulses as narrow as a few microseconds, or to obtain a spectrum whose timing exceeds the maximum 6.5 ms delay of the ADC trigger mode.

- 1 On the front panel press Bandwidth > Sweep > More BW Sweep > Functions > Trigger Mode.
- 2 Select from int, gated, and ext.

Moving the Active Function Area

The active function area on the display can be moved to eight different locations. This allows you to place the active area in a location that will not interfere with the trace information. Refer to "Active Function Area Assist" on page 3-2.

- 1 Press the front-panel System key.
- 2 Press the Move Active Area softkey. Each press of the softkey moves the active function area to one of eight onscreen locations.

Indicating an Update is Needed

This feature alerts you to take a sweep after changing any sweep related parameters when the analyzer is not in sweep mode. For example, if you change the resolution bandwidth, the new resolution bandwidth is displayed on the bottom of the screen, but the trace data displayed on the screen used the previous resolution bandwidth value.

Changing the following sweep parameters will set the Update Needed Indicator to on:

- start wavelength
- stop wavelength
- sensitivity auto/manual
- auto range enable/disable
- sensitivity
- video bandwidth auto/manual
- resolution bandwidth
- video bandwidth
- gated sweep enable/disable
- sweep continuous/single
- sweep time auto/manual
- sweep time
- sweep trace length
- reference level
- dB per division
- reference level position
- Y scale linear/log mode
- amplitude correction enable/disable
- current active ampcorr correction set
- ampcor interpolation method
- vacuum or air
- wavelength offset
- number of averages for trace averaging

The Update Needed Indicator, "***", is displayed in the upper right hand corner of the graticule. After a sweep is taken, the Update Needed Indicator will be set to off.

Calibrating Wavelength Measurements

Environmental variations such as air pressure, temperature, and humidity can affect the index of refraction of air in the monochromator of the optical spectrum analyzer (OSA). This section discusses calibration methods that you can use to improve the wavelength accuracy in the Agilent 8614xB OSA's. Refer to "Calibration" on page 3-16 and to "Calibrator Multi-Pt Align" on page 3-16.

Note

Many aspects of remotely programming the optical spectrum analyzers are discussed in Product Note 86140-2R, *Wavelength Calibration for the 86140X Series Optical Spectrum Analyzers (Literature part number 5980-0043E)*.

Overview

Wavelength calibration routines improve wavelength accuracy by determining errors and correcting them with offsets, using linear interpolation when necessary. For maximum wavelength accuracy, calibration points spaced a maximum of 10 nm apart are recommended.

You can perform a wavelength calibration by using one of the following methods:

- Manual Method using Internal Calibrator
- Remote Method using Internal Calibrator
- Manual Method using an External Single Wavelength Source
- Remote Method using an External Single Wavelength Source
- External Multipoint Wavelength Calibration

These calibration routines should only be performed after the instrument's temperature has been stabilized by a minimum of 1 hour of continuous operation.

Internal Wavelength Calibration

The optional internal calibrator (1513 to 1540 nm) provides a convenient method for increasing wavelength accuracy when used with an internal Enhanced Wavelength Calibration (EWC) process. The wavelength accuracy of the OSA will be ± 0.2 nm over the full wavelength range of the instrument, with ± 10 pm over 1480 to 1570 nm and ± 25 pm accuracy over 1570 to 1620 nm.

The EWC range can be selected for either the "full" OSA range of 605 nm to 1670 nm, or the "telecom" range of 1270 to 1670 nm, a smaller span more relevant to telecommunications. EWC must be enabled for the wavelength accuracy specifications to apply in the range selected. Setting the range to FULL will require a longer calibration time for an internal calibration, but will provide enhanced wavelength accuracy over the full range.

Manual method using the internal calibrator

- 1 Access the EWC setup panel:
System > More System Functions > Service Menu > Adv Service Functions > More Adv Service Menu > Enhanced Wvl Cal Setup
- 2 Enable the function, if necessary, and select the desired calibration range.
- 3 Clean all connectors and connect the internal calibrator to the OSA input.
- 4 Access the Wavelength Calibration setup panel:
System > Calibration > Wavelength Cal Setup
- 5 Set the signal source to Calibrator.
- 6 Press Perform Calibration.

Remote method using the internal calibrator

CALibration:WAVelength:EWC:FUNction ON

!Enable enhanced wavelength calibration.

CALibration:WAVelength:EWC:RANGe TELE

!Select telecom (1270-1670) nm range for enhanced wavelength calibration.

CALibration:WAVelength:INTernal:NORMAL

!Perform internal wavelength calibration.
!The internal calibrator must be connected before sending this command.

External Single Wavelength Calibration

Using an external single-point calibration source allows the calibration to be done at a specific wavelength. This single wavelength user calibration can be repeated as often as necessary to correct for environmental variations and existing multipoint wavelength offsets will be adjusted accordingly. After a single wavelength calibration, wavelength accuracy will be ± 10 pm within 10 nm of the reference signal.

The Enhanced Wavelength Calibration (EWC) process can also be used to increase the accuracy of the single-point calibration.

Manual method using an external source

- 1 Connect the external source to the OSA input.
- 2 Auto align the OSA to the input signal.
- 3 Access the Wavelength Calibration setup panel:
System > Calibration > Wavelength Cal Setup
- 4 Select Air or Vacuum reference for the signal source.
- 5 Set the signal source to External.
- 6 Select the desired Calibration Wavelength. This wavelength must be within ± 2.5 nm of the source wavelength.
- 7 Select Perform Calibration.

Remote method using an external source

- For a source with a single peak:

CALibration:WAVelength:VALue <param>	!Set calibration wavelength
CALibration:WAVelength	!Calibrate signal at wavelength

- For a source with multiple peaks:

CALibration:WAVelength:VALue <param>	!Set calibration wavelength
CALCulate:MARKer[1 2 3 4]:X:WAVelength <param>	!Set marker wavelength
CALibration:WAVelength:MARKer	!Calibrate signal at marker

External Multipoint Wavelength Calibration

An external multipoint wavelength calibration can be performed over any specified wavelength range, up to and including the full wavelength range of the OSA (600 nm to 1700 nm). Narrow measurement spans can be chosen to provide greater accuracy over a selected range. Calibrating the wavelength every 10 nm within the desired wavelength range is usually sufficient to improve wavelength accuracy. After a multipoint wavelength calibration, wavelength accuracy will be ± 10 pm within 10 nm of each calibration wavelength. Refer to "Calibrator Multi-Pt Align" on page 3-16.

Note

For a full explanation of external multipoint wavelength calibration, along with a sample program to perform the calibration, refer to Product Note 86140-2, *Wavelength Calibration for the 86140X Series Optical Spectrum Analyzers (Literature part number 5980-0043E)*.

The following steps outline one method for an external multipoint wavelength calibration routine. This assumes a program executed on an external PC controller. The steps outlined are those written in the program.

- 1 A signal is sent from a tunable laser source into a multi-wavelength meter and the OSA simultaneously.
- 2 The wavelength of the input signal is measured on both instruments.
- 3 The two measured values are compared.
- 4 Taking the multi-wavelength meter readings as actual, the software calculates the error offsets at each wavelength using the equation:
$$\text{WL Error} = (\text{OSA indicated WL}) - (\text{multi-wavelength meter actual WL})$$
- 5 The previous steps are repeated over the entire wavelength range.
- 6 The data is averaged over narrow wavelength spans to provide a suitable correction for each span. The example below demonstrates this technique.

Once the instrument is calibrated, the new wavelength accuracy can be maintained for many hours without recalibration, assuming a stable temperature environment.

Tip

If the OSA is turned off, the multipoint data will be retained at the next power-on, but the internal thermal shift can introduce inaccuracies to the calibration data. To help compensate for this, a single point calibration using the Offset feature in the Wavelength Calibration Setup panel can be used to adjust the multipoint data. Access this feature by selecting System > Calibration > Wavelength Cal Setup and choosing the Offset option before running the single point calibration.

To insure this offset process has provided sufficient accuracy, the wavelength readings of the multi-wavelength meter and the OSA should be compared to verify the wavelength accuracy and determine if a full multipoint wavelength recalibration is necessary.

Saving, Recalling, and Managing Files

The functions and methods available for saving, recalling, and managing files that contain measurement setups and results are as follows:

- Adding a Title to the Display
- Backing Up or Restoring the Internal Memory
- Saving Measurement Trace Data
- Recalling Measurement Trace Data
- File Sharing and Printing over a Network

Adding a Title to the Display

Refer to “Title (Display Setup Panel)” on page 3-85 and to “Date/Time (Display Setup Panel)” on page 3-19.

- 1 Press the front-panel System key.
- 2 Press the Set Title.... softkey. The Title Setup panel appears.

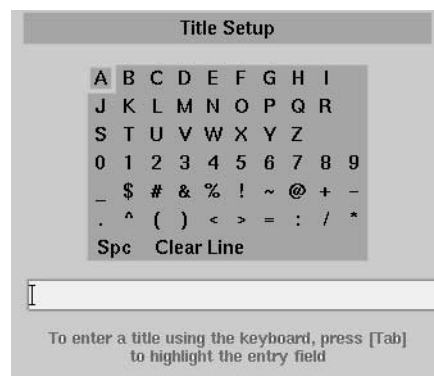

The Title Setup panel

- 3 To view the title on the display, press More System Functions >Display Setup and check the Title On box.

Backing Up or Restoring the Internal Memory

- 1 Press the front-panel Save/Recall key.
- 2 Press the Backup/Restore Menu.... softkey.

Note The auto span value will not be saved with the measurement. Refer to “Backup Internal Memory” on page 3-13.

Softkey Panel Selections *Backup Internal Memory*

- a The analyzer Backup Utility screen appears asking you to insert a formatted floppy disk in the external drive. The disk will not be viewable on a PC and no trace or measurement files can be saved onto the disk until it is reformatted.
- b The Backup Internal Memory function overwrites the floppy disk with a new image. Any existing files or catalogs on the floppy disk will be destroyed. Any successive backup operations will overwrite the previous backup information, so only the latest backup information can be recovered through the Restore Internal Memory operation.

Restore Internal Memory

The analyzer Restore Utility screen appears. This operation will remove all files from internal memory and replace them with files from backup floppy disks.

Saving Measurement and Trace Data

You can save measurement and trace data using the following methods:

- Fast Measurement Save Mode
- Save Setup Panel Mode

Saving Data in Fast Meas Save Mode

- 1 Press the front-panel Save/Recall key.
- 2 Press the Fast Meas SAVE softkey.
- 3 The instrument saves the current measurement state to internal memory as FASTSAVE.dat. Only one FASTSAVE.dat file exists, so performing a Fast Meas Save will overwrite any currently existing Fast Save file.

Note The auto span value will not be saved with the measurement.

Saving Measurement and Trace Data

- 1 Press the front-panel Save/Recall key.
- 2 Press the Save Menu.... softkey.
- 3 The Save Setup panel opens. Refer to "Adjusting Setup Conditions" on page 2-3 for information on changing and selecting items in the setup panel.

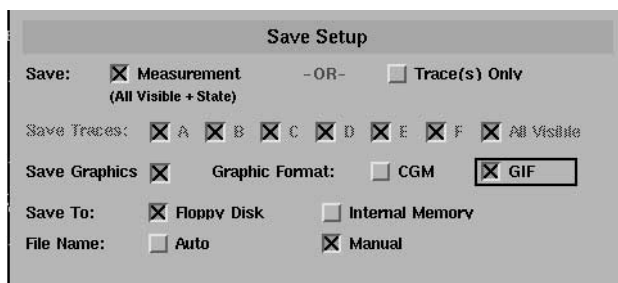

The Save Setup panel

Note The auto span value will not be saved with the measurement.

Save Setup Panel
Selections

Save: Measurement

Saves the measurement data in a binary format (.dat file). This includes the traces and all measurement conditions. The dat file format can only be read by the analyzer. You will not be able to view this file on your PC. When the file is recalled, the instrument state will be set to the same state as when the file was saved.

Save: Trace(s) Only

The Trace(s) Only files are saved in comma separated variable (.csv) format and are auto named starting with TR_00000.csv. State files are auto named starting with ST_00000.csv.

When the Trace(s) Only file is recalled, the trace data will be displayed *under the current instrument settings*. To view the instrument settings, press System > More System Functions > State Info.

Save Traces

Selects the traces to be saved.

Save Graphics

Allows you to save graphic data in one of two formats. These selections are valid only when saving to the floppy drive.

CGM (Computer Graphics Metafile format) is a vector graphics format that describes pictures and graphical elements in geometric terms. The file is saved with .cgm extension.

GIF (Graphics Interchange Format) is a cross-platform graphic standard. GIF formats are commonly used on many different platforms and readable by many different kinds of software. The file is saved with .gif extension. GIF supports up to 8-bit color (256 colors).

Save to

Allows you to choose between saving data to a floppy disk or to internal memory.

File Name

Selects manual or automatic mode for choosing a file name.

- 4 If you have chosen Auto to select the file name, press the Auto Save softkey. The analyzer will generate a filename and save the file.
- 5 If you have chosen Manual to select the file name, press the Choose File to Save softkey. The Filename Menu setup panel opens.

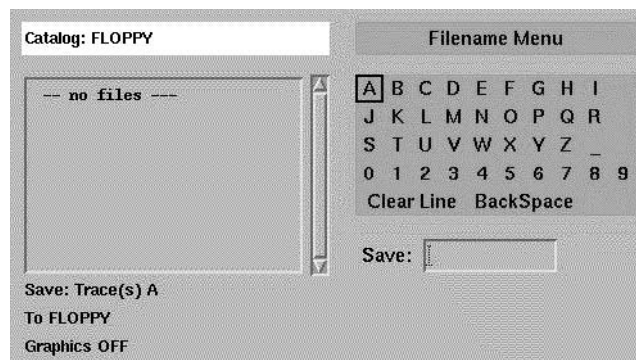

The Filename Menu setup panel

Entering a Filename Using the Arrow Keys

- Use the front-panel step keys (⏪ and ⏩) and the arrow softkeys (← and →) to highlight each letter

Using the Instrument
Saving, Recalling, and Managing Files

of the filename.

- When the desired letter or function is selected, press the Select softkey.
- Select the BackSpace function to delete individual letters.
- Select the Clear Line function to delete the entire filename.
- When you finish entering the filename, press the SAVE FILE softkey.

Entering a Filename using an External Keyboard

There must be a PS-2 keyboard connected to the analyzer prior to bootup.

- Press [TAB] on the keyboard to highlight the entry field.
- Enter the filename using the keyboard.
- When you finish entering the filename, press the *SAVE FILE* softkey.

Recalling Measurement and Trace Data

You can recall measurement and trace data using the following methods:

- Fast Measurement Recall Mode
- Recall Setup Panel Mode

Refer to “Recall (Recall Setup Panel)” on page 3-61.

Recalling Data in Fast Meas Recall Mode

- 1 Press the front-panel Save/Recall key.
- 2 Press the Fast Meas RECALL softkey.
- 3 The instrument recalls the measurement state previously saved as FASTSAVE.dat by the Fast Meas Save function.

Note The auto span value will not be saved with the measurement.

Recalling Measurement and Trace Data

Note To insure accurate measurements, a wavelength calibration should be performed each time measurement data is recalled from memory.

- 1 Press the front-panel Save/Recall key.
- 2 Press the Recall Menu.... softkey.
- 3 The Recall Setup panel opens.

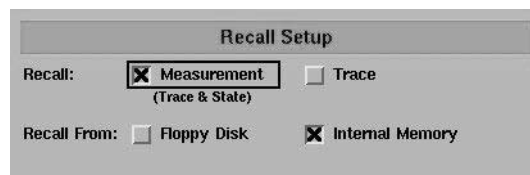

The Recall Menu setup panel

Note The auto span value will not be saved with the measurement.

Recall Setup Panel
Selections

Recall
Selects whether a measurement or trace will be recalled.

Using the Instrument
Saving, Recalling, and Managing Files

Recall From

Selects whether to recall from a floppy disk or from internal memory.

- 4 When you are satisfied with your selections, press the Choose File to Recall softkey. The Catalog setup panel opens.

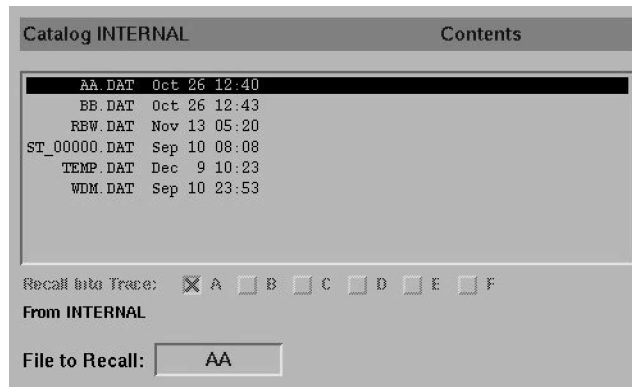

The Catalog setup panel

- 5 Use the arrow keys or Prev File, Next File softkeys to highlight the desired file. Press RECALL FILE to load the selected file.

File Sharing and Printing over a Network

This function uses the LAN to print to network printers and store, recall or delete data on remote hard drives. The data can then be accessed and shared among the users and printed on designated printers.

To access the file and printer share softkeys, you must first configure the network and enter the user share identity/user profile information for remote shares. The softkeys for file and printer share will then become available for selection.

Create a file or print share.

- 1 Configure the network. Refer to "Setting Up the OSA for Remote Operation" on page 4-4 for instructions on how to configure the network.
- 2 From the front panel, press System > More System Functions > GPIB & Network Setup > User Share Identity.
- 3 Enter the User Name, Password, and Workgroup. Use the keyboard to enter the information or press Edit Field to access the User Workgroup Setup panel then close the panel.
- 4 From the Network Setup, press File Share and enter the Share Path and optional IP address. The format of the share path is "\\server\" share name." Please note that you cannot specify directories within the share. Up to four remote file shares are available.
- 5 Press Printer Shares and enter the share path and optional IP address. Use the keyboard to enter the information or press Edit Field to access the User Workgroup Setup panel. Up to four remote printer shares are available.
- 6 To activate the printer share, press System > Printer Setup and select the configured share. To activate the file share, press Save/Recall then either Save, Recall or Delete and select the configured share. Note if you have not configured the share the Network File Share buttons will not be active.

Analyzing Measurement Data

This section provides advice and information on the following analyzer functions that allow you to analyze the measured amplitude wavelength data.

- Tips for Using Traces and Markers
- Measuring the Delta between Traces
- Using Trace Math to Measure Wavelength Drift

Tips for Using Traces and Markers

The analyzer provides the ability to display up to six traces with up to four markers. Knowing a few tips makes trace and marker manipulation much easier. Refer to “Traces” on page 3-87, “Marker BW” on page 3-33, “Marker Search Menu” on page 3-34, “Marker Setup” on page 3-35, and “More Marker Functions” on page 3-40.

- Markers are always placed on the currently selected active trace. Therefore, use the Active Trace function to activate the desired trace, then select an active marker to be placed on that trace.
- When multiple markers are currently used on multiple traces, the Marker Status area (located at the top of the display) makes it easy to identify the state of each marker.

Information provided for each marker includes:

- Wavelength
- Amplitude
- The trace associated with the marker.

For example, if marker 1 is on Trace A then the annotation will show
Mkr 1 (A).

In addition, if there are two markers on, then the delta of the wavelength and amplitude for the two different markers is also displayed. For example, Mkr (2-1) 0.206 nm, -0.002 dB.

The color of the annotation denotes different characteristics of the markers:

- White annotation denotes the status of the currently active marker.
- Green annotation denotes the status of all currently used markers.
- Red annotation denotes that some type of an error occurred with the marker measurement.

Moving the Active Marker from One Trace to Another

The following procedure shows you how to move the active marker (marker 1) from Trace A to Trace B.

- 1 From the front panel, press Markers > Active Trace > TrB to make Trace B the active trace.
- 2 Press Active Marker > Mkr 1.

Measuring the Difference between Traces

The following procedure shows you how to find the amplitude and wavelength difference between the maximum peaks of two different traces. Refer to "Normal/Delta Marker Interpolation (Marker Setup Panel)" on page 3-44.

- 1 From the front panel, press Markers > Active Trace and select the first trace to place a marker.
- 2 Press Active Marker > Mkr 1 > Peak Search to place the marker on the highest peak of the active trace.
- 3 Press Active Trace and select the second trace to place a marker.
- 4 Press Active Marker > Mkr 2 > Peak Search to place the marker on the highest peak of the second trace.
- 5 View the results of the measurement from the marker annotation at the top of the display.

The wavelength and amplitude of each trace marker is shown, as well as the amplitude and wavelength difference of the peaks of the two traces.

Using Trace Math to Measure Wavelength Drift

- 1 From the front panel, press Traces > Active Trace > TrA.
- 2 Press Single Sweep, Bandwidth Sweep, Single Sweep to update Trace A then press Traces, Update A off.
- 3 Press Active Trace > TrB.
- 4 Press Sweep > Repeat Sweep On to continuously update the measured response on Trace B.
- 5 Press Traces > Trace Math, Default Math Trace C > Log Math C = A – B.

You can now monitor the wavelength drift of your device over time.

Also Refer to “Log Math C=A–B” on page 3-31, “Log Math C=A+B” on page 3-32, and “Log Math F=C–D” on page 3-32.

Analyzer Operating Modes

This section discusses the following analyzer modes that you can use in specific measurement applications.

- Filter Mode (For Agilent 86146B only)
- Time Resolved Chirp

Filter Mode

For Agilent 86146B only

The Agilent 86146B filter mode allows a single channel from a dense wavelength division multiplex (DWDM) signal to be isolated and routed to another measurement instrument. The filter mode capability is built-in to internal applications to allow for fast and easy measurements. The filtering is accurate and flexible. It has low polarization dependent loss (PDL), adjustable filter bandwidth, and a wide tuning range.

- Switch to filter mode by pressing Appl > Measurement Modes > Filter Mode.
- Select a filter bandwidth in the BW/sweep > Res BW menu.
- Select an active tuning marker and tune it to a wavelength position.

The filter marker becomes the current marker and has the active area focus. All other markers stay on. In the filter mode, the analyzer acts as a fixed-tuned, variable wavelength, variable bandwidth, bandpass filter. It filters the input light at a specified wavelength. The filtered light is available at the front-panel monochromator output connector. One application of the filter mode is the filtering (selecting) of one particular mode of a laser source. Refer to "Filter Mode" on page 3-26, "Filter Mode Instruction Panels" on page 3-26, and "Filter Marker Tune" on page 3-25.

When the analyzer enters the filter mode, the sweep stops with the analyzer filter tuned to the center wavelength. (If a marker is on, the analyzer filter is tuned to the marker wavelength.) The last trace remains displayed to show the input spectrum before the filtering. A marker shows the wavelength of the preselection. You can change the filtered output (preselection) wavelength by

Using the Instrument
Analyzer Operating Modes

adjusting the marker's position, then connecting the monochromator output to another instrument. If the input spectrum changes, reconnect the monochromator output, then press the Take Sweep softkey to capture a new sweep.

The single mode filter can be used in conjunction with the Agilent 86130A bitalyzer error performance analyzer and/or the Agilent 86100A infinium digital communication analyzer. Time resolve chirp (TRC) measurements use the Agilent 86146B Option TRC and the Agilent 86100A digital communication analyzer.

Table 2-6. Agilent 86146B unique operation

86146B Unique Operation (External 9 μm Fiber Connection)	
Filter mode initialization:	
<ul style="list-style-type: none"> No default settings 	
Markers used:	
<ul style="list-style-type: none"> Filter marker is the normal noise marker OSNR marker is the center marker Bandwidth marker is the center wavelength marker 	
Functions limited to:	
<ul style="list-style-type: none"> Fiber selection Applications Calibration ADC 	
Filter mode functions available:	
<ul style="list-style-type: none"> Transfer and restore state file in filter mode Save in filter mode 	

Accessing the filter mode (for 86146B only)

Note	<p>Filter mode will not function in zero span. The filter mode selection will be shaded out. The current state before entering filter mode will not be saved. A sweep will not be taken. The reference level will not change.</p> <ol style="list-style-type: none"> 1 Connect the light source to the optical spectrum analyzer's front panel monochromator input connector. 2 Connect the monochromator output to the photodetector input. 3 Press Appl's > Measurement Modes > Filter Mode. Follow the external path align setup instructions and select either the Switch Path Auto Align Now or Switch Path No Auto Align. <ul style="list-style-type: none"> • Select the Switch Path Auto Align Now to perform an automatic alignment of the external path. • Select Switch Path No Auto Align if you do not have the monochromator output connected to the photodiode input, or to preserve previous align data.
------	--

Using the Instrument
Analyzer Operating Modes

Switch Path Auto Align Now switches to the 9 μm filter mode path and performs an Auto Align. This aligns the output of the monochromator with the photodetector input for improved amplitude accuracy. The automatic alignment procedure should be performed whenever the instrument has been:

- moved
- subjected to large temperature changes
- turned off, then on, and warmed up for an hour

The automatic alignment requires the connection of an external light source. This can be a broadband or narrowband source. If there is insufficient signal power, the automatic alignment will not be performed and an error message will be reported.

The Auto Align function saves and restores the current instrument state. This allows the auto align to be used in the middle of a measurement routine.

If markers are turned on, auto align attempts to do the automatic alignment at the wavelength of the active marker.

Note

Auto Align Now will overwrite any previous align data.

The data returned by the alignment is stored for both the external (9 μm) and the internal (50 μm) path. With the data stored for both paths, the alignment for the internal path is improved due to the increased resolution bandwidth of the external path. Once the align is complete or if you select No Auto Align, the instrument will be ready to detect data through the external path.

- 4 After the routine has finished, check that the display shows the wavelength range of interest of the external path. Adjust if necessary.
- 5 Press Res BW. Use the knob, step keys, or numeric keypad to enter the desired amount of resolution bandwidth filtering.

The 9 μm optical path for filter mode uses the 0.04 nm resolution bandwidth. The resolution bandwidths include 0.04 nm, 0.05 nm, 0.07 nm, 0.1 nm, 0.2 nm, 0.3 nm, 0.5 nm, 1 nm, 2 nm, 5 nm, and 10 nm.

- 6 Press Take Sweep to update the display to show the results of the new resolution bandwidth filtering.

The light is output from the optical spectrum analyzer's front panel monochromator output connector. This light is filtered (by the resolution bandwidth) and attenuated (by the monochromator loss) light that is input to the front panel optical input connector.

- 7 Press Optical Filter Marker Tune. Turn the front panel knob or press the step keys to tune the preselector to any displayed wavelength.
- 8 Connect the monochromator output to an instrument.

- 9 If the input light changes, or if you change the span of the optical spectrum analyzer, reconnect the monochromator output to the photodetector input, and press Take Sweep to update the displayed trace with valid waveform data.
- 10 Press Exit Filter Mode to return to normal optical spectrum analyzer operation.

The filter mode Save/Recall function for the Agilent 86146B will work only in this model.

Note

If the file saved in filter mode is recalled into an instrument with firmware revision B.04.02, a critical error occurs, indicating a grating positioning failure. Restart the instrument to clear the error and then continue making measurements.

Time Resolved Chirp

For Agilent 86146B option DPC only

The Agilent 86146B, with the filter mode capability, will measure side mode suppression ratio (SMSR), wavelength, and power. With the addition of an Agilent 86100 Infinium Digital Communications Analyzer (DCA), dedicated software (86146B Option TRL), and a personal computer, time resolved chirp (TRC) of a modulated laser can be calculated.

TRC provides frequency (or wavelength) vs time information about a modulated lightwave signal. Also called dynamic chirp, the TRC graph provides useful information on the ability of a modulated signal to propagate over long distances in optical fiber. In dense wavelength division multiplexing (DWDM) systems, excessive chirp also can cause inter-channel interference. The two significant factors of chirp are:

- dispersion which is a function of the transmission link's length and fiber type
- cross talk caused by chirp due to closely spaced channels

A measurement could show the modulated signal (square wave) and the chirp. The chirp fluctuates with time and the frequency change, seen at the falling and rising edge of the time domain. The time resolved chirp solution measures:

- intensity versus time
- frequency versus time
- calculates the alpha factor

The alpha factor is also referred to as linewidth enhancement factor. One definition of α is:

$$\alpha = 2P(Df) / (Dp)$$

During initialization, the instrument does an auto peak, gathers information about the peaks, and tunes the filter marker. The unmodulated data is shown in the square wave pattern and the chirp is the frequency which runs through the square wave pattern.

To smooth the chirp signal, increase the averages taken which will decrease the noise found on the signal. Increasing the number of averages and using the longer patterns will increase the measurement processing time. To shorten the measurement processing time, either increase the power or decrease the number of averages. See the TRC Option User's Guide for more details.

————— Function Reference

Function Reference

This chapter is an alphabetical reference of front panel keys, softkeys, and setup panel parameters. It is designed for quick information access. For example, during an operation you may find a key whose function is unfamiliar to you. Note the key name and look the key up in this chapter.

Active Function Area Assist

Sets the active function area to the first or top softkey function. When this function is on, the active area is automatically set. For example, when you press the front-panel Wavelength key, the active function area assist will set the active function to the Center WL. You can immediately enter the desired center wavelength without pressing the Center WL softkey. If this function is off, the active dialog box will not appear on the display. To access the individual dialog box, press the desired softkey function.

Key Path System > More System Functions > Display Setup

Related Functions Move Active Area

Active Marker

Accesses the menu that allows you to select an active marker. Selecting a marker always places that marker on the center wavelength of the active trace. Up to four markers can be simultaneously displayed. If multiple markers are displayed, the active marker appears as a white diamond and the other markers appear as green diamonds. The Mkr notation on top of the graticule area indicates the trace where the marker is located. For example, Marker 2 on trace B would read Mkr 2(B).

See “Tips for Using Traces and Markers” on page 2-26, and “Measuring the Difference between Traces” on page 2-27.

Key Path	Markers > Active Marker
Related Functions	Active Trace, Peak Search, Pit Search, Marker to Center, Marker to Reference Level
Remote Commands	CALCulate[1 2 3 4 5 6]:MARKer[1 2 3 4]:STATe CALCulate[1 2 3 4 5 6]:MARKer[1 2 3 4]:AOFF

Active Trace

Accesses the menu that allows you to select an active trace for viewing, updating, or storing. The trace must be active before you can put a marker on it or make changes to it. There are six traces available.

See “Tips for Using Traces and Markers” on page 2-26, and “Measuring the Difference between Traces” on page 2-27.

Key Path	Traces > Active Trace Markers > Active Trace
Related Functions	Trace Math, View (Trace), Update (Trace)
Remote Commands	CALCulate[1 2 3 4 5 6]:MARKer[1 2 3 4]:TRACe TRACe:FEED:INPute TRA,2 TRACe:FEED:CONTRol:TRA, ALWays DISPlay:WINDow:TRACe TRA, ON

Adv Service Functions

Accesses the following functions:

- Grating Order
- More Adv Service Menu
- Wavelength Limit
- Zero Now

Key Path System > More System Functions > Service Menu > Adv Service Functions

Advanced Line Mkr Functions

Accesses the following functions:

- integrate limit
- search limit
- sweep limit
- trace integ

Key Path Markers > More Marker Functions > Line Marker Menu > Advanced Line Mkr Functions

Agilent Logo (Display Setup Panel)

Accesses the panel that allows you to turn the Agilent logo on or off. When this function is on, the Agilent logo appears on the display's upper, left corner of the graticule and on printouts.

Key Path System > More System Functions > Display Setup

All Math Off

Turns all the trace math functions off.

Key Path Traces > Trace Math Off > All Math Off

All Off

Turns all the active markers off.

Note If filter mode is on, this function is not available.

Key Path Markers > Active Marker > All Off

Remote Commands CALCulate[1 | 2 | 3 | 4 | 5 | 6]:MARKer[1 | 2 | 3 | 4]:AOFF

Amplitude

Accesses the menu of keys that allow you to control the instrument's sensitivity and amplitude scales. The function keys include:

- amplitude setup
- display mode
- peak to ref level
- reference level
- scale/div
- sensitivity
- trace integ

Key Path Amplitude

Amplitude Setup

Accesses the Amplitude Setup panel that allows you to specify amplitude related functions:

- amplitude correction mode
- amplitude correction sel
- amplitude units
- auto chop mode
- auto ranging
- auto zero
- power calibration
- reference level position
- user power cal date

Function Reference
Amplitude Setup

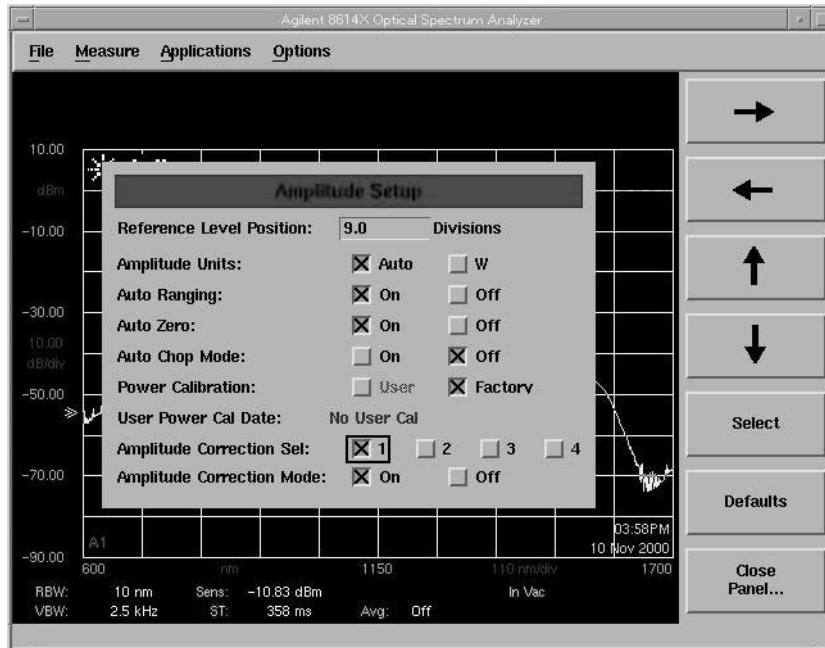

The Amplitude Setup panel

Setup Panel Selections

Reference Level Position

The value selected for the Reference Level Position determines the position of the reference level on the graticule. Setting this value to zero divisions places the reference level on the very bottom of the grid. Setting the reference level to 10 divisions places the reference level at the top of the grid. Pressing the front-panel Preset key resets the reference level to 9.0 divisions.

Note

When using the knob or step keys, the value will automatically change. When using the numeric entry pad, enter a terminator that is selected from the softkey panel.

Amplitude Units

Selecting Auto for amplitude units allows power to be shown in dBm when using the logarithmic scale, and in watts when using the linear scale. Selecting W forces the immediately displayed information to be in watts, regardless of the amplitude scaling.

Auto Ranging

The Auto Range function allows the OSA to automatically change the gain of the transimpedance amplifier during a sweep. This allows measurements to be made at the largest dynamic range and at the fastest sweep speed.

Pressing the front-panel Preset key turns Auto Ranging ON.

Note

It is recommended that Auto Ranging always be turned on.

Auto Zero

Turns Auto Zero ON and OFF. Auto Zero ON enables the internal amplifiers to be zeroed between sweeps. Selecting OFF disables this feature. Pressing the front-panel Preset key resets this function to ON.

Note

Turning Auto Zero off allows the instrument to sweep faster, but results in less accuracy on low level signals. The optical spectrum analyzer performs a more complete zeroing when the instrument is first turned on. You can run this more complete routine anytime by pressing the Zero Now softkey.

Auto Chop Mode

(Not available on 86146B models)

Enables the optical spectrum analyzer chop mode. Chop mode increases dynamic range for long sweep times by subtracting ambient light. Subtracting the ambient light can improve sensitivity but slows down the sweep speed.

Pressing the front-panel Preset key turns this function OFF.

Note

Sweep times of $50 \text{ msec} \times \text{the \# of trace points}$, or longer, use a special "chop" mode. Chop mode increases dynamic range, stabilizes measurements against drift, and reduces effects of stray light. This special chop mode is enabled by setting the Auto Chop mode to on.

Power Calibration

Power Calibration allows you to use amplitude correction factors either from the factory calibration or from the last successful user calibration. Pressing the front-panel Preset key resets this function to User. If a user calibration has not been performed, the factory calibration data is used.

User Power Cal Date

The User Power Cal Date displays the date of the last successful user-performed amplitude calibration.

Function Reference
Amplitude Units (Amplitude Setup Panel)

Amplitude Correction Sel

Allows you to select a correction set to be applied to the measurement results. Only one set can be selected at a time. Refer to "Amplitude Correction Remote Commands" on page 1-24 of the "Agilent 8614xB Series Optical Spectrum Analyzer Programming Guide" for an overview of the amplitude correction remote commands.

Amplitude Correction Mode

Allows you to turn the AMPCOR ON or OFF.

When AMPCOR is turned on, the correction points are applied across the active measurement range and added to all measurement results. Between points, the correction values are interpolated linearly or logarithmically. When measuring at wavelengths outside the first and last correction points, the first or last value (as appropriate) is used as the correction value.

Whenever AMPCOR is active, the currently selected correction set is displayed in the lower left corner of the screen. For example, if correction set number one is selected, "A1" is displayed. Refer to "Amplitude Correction Remote Commands" on page 1-24 of the "Agilent 8614xB Series Optical Spectrum Analyzer Programming Guide" for an overview of the amplitude correction remote commands.

Key Path	Amplitude > Amplitude Setup...
Related Functions	Reference Level, Sensitivity
Remote Commands	(Amplitude Display Mode):DISPlay:WINDow:TRACe:Y:SCALe LINear DISPlay:WINDow:TRACe:Y:SCALe LOGarithmic (Amplitude Units):UNIT:POWer (Auto Zero):CALibration:ZERO (Reference Level Position):DISPlay:WINDow:TRACe:Y:SCALe:RPOsition

Amplitude Units (Amplitude Setup Panel)

Selects the amplitude scale's units. Selecting Auto for amplitude units allows power to be shown in dB when using the logarithmic scale and in watts when using the linear scale. Selecting W forces the readout to be in watts, regardless of the amplitude scaling.

Key Path	Amplitude > Amplitude Setup > Amplitude Units
Related Functions	Display Mode, Trace Marker, Scale/Div

Remote Commands UNIT:POWer

Auto Align

Pressing the auto align button on the front panel of the instrument performs an automatic alignment of the instrument using the largest signal found in a full span sweep. This aligns the output of the monochromator with the photodetector for improved amplitude accuracy. To ensure maximum amplitude accuracy and stability, connect an input signal to the instrument, mark the peak of the signal, and then press Auto Align. This starts an automatic alignment procedure that should be performed whenever the instrument has been:

- moved
- subjected to a 2° temperature change
- restarted and warmed up at the start of each day

The automatic alignment requires the connection of an external, broadband or narrowband, light source. If there is insufficient signal power, the automatic alignment will not be performed and an error message will be reported.

The auto align function saves and restores the current instrument state. This allows the auto align function to be used in the middle of a measurement routine.

If markers are turned on, the auto align function attempts to do the automatic alignment at the wavelength of the active marker. If the instrument is in zero span, the alignment is performed at the center wavelength.

Key Path Auto Align

Related Functions Auto Meas
Auto Align & Add to Trajectory
Calibrator Multi-Pt Align
User Source Multi-Pt Align

Remote Commands CALibration:ALIGn
CALibration:ALIGn:MARKer[1 | 2 | 3 | 4]

Auto Align & Add to Trajectory

Allows alignment at several wavelengths, ensuring amplitude accuracy of your measurements. Before initiating the alignment, connect a broadband light source to the front-panel input connector. (You may add and/or update the existing points in the trajectory table.) Press Auto Align Preset to clear the table.

Turn on an active marker and manually place the marker at the desired wavelength. If an active marker is not turned on, the instrument will automatically turn on an active marker and auto align at the largest input signal. The minimum recommended spacing between points is 5 nm for the external, single mode fiber (Agilent 86146B only) and 50 μm for the internal, multi-mode fiber. The span must be >3 nm for the single mode fiber and >25 nm for the multi-mode fiber.

Note

Error 5001, Auto align cannot find input signal, will occur if a broadband light source is not connected to the front-panel input connector.
Error 5070, Trajectory Add Failed, will occur if the trajectory table is full or the computed trajectory table is invalid.

Key Path

Systems > More System Functions > Service Menu > Adv Service Functions > More Adv Service Menu > Multi-Point Align > Auto Align & Add to Trajectory

Related Functions

Auto Align Preset
Calibrator Multi-Pt Align
User Source Mutli-Pt Align

Remote Commands

CALibration:ALIGn:TADD

Auto Meas

Pressing the Auto Meas button on the front panel of the instrument performs an automatic measurement of the largest signal found in a full span sweep and places a marker at the signal peak. The signal must have at least 10 dB of excursion. (Refer to "Peak Excursion (Marker Setup Panel)" on page 3-51 for additional information.) Auto measure requires the connection of an external, broadband or narrowband light source. If there is insufficient signal power, the automatic measurement will not be performed, and a warning message will be reported. This automatic measurement routine is normally the best way to adjust sensitivity while maintaining the fastest sweep rates.

The auto measure function uses trace A to perform the measurement. Since the auto measure function can alter the instrument state, we recommend that this operation be performed before a measurement sequence is started.

Auto Measure Setup panel allows you to modify the auto measure span and the vertical scale, tune to the wavelength indicated by the marker, and optimize the sensitivity.

Span selects the wavelength span for viewing the signal located by the auto measure function. If auto is specified, the span is set wide enough to display most of the signal. If a particular span is desired, deselect auto and put the desired span in the nm dialog box. The default selection for span is auto.

Note

If the span is set too narrow, the auto measure operation may not complete successfully. If this happens a warning message is displayed.

Scale/Div selection sets the vertical scale to be used after performing the auto measure function. If auto is specified, the measurement function sets the vertical scale to a value based on the dynamic range of the signal. If a particular vertical scale is desired, deselect auto and put the desired dB/div in the dB dialog box. The default selection for dB/div is auto.

AutoMeas at Marker turns the auto measure marker on or off. Selecting the on state for auto measure at marker causes the auto measure function to perform its operation at the wavelength of the active marker. This allows you to measure a signal other than the largest one found in a full span sweep. The default selection for auto measure at marker is off.

Optimize Sensitivity, when turned on, causes the auto measure function to set the sensitivity so the resulting measurement has a minimal amount of noise. It does this by finding the minimum in the measurement trace and comparing this value to the known sensitivity of the instrument at that wavelength. Sensitivity is then reduced until the signal is close to this minimum sensitivity or the sweep time becomes too long. The Optimize Sensitivity function is useful when viewing high dynamic range signals. The drawback to turning this function ON is that it generally requires a longer sweep time to get better sensitivity. The default selection for Optimize Sensitivity is OFF.

Note

None of the Automeasure Setup parameters are affected by the front-panel Preset key. They are not saved as part of the measurement setup.

Key Path

Auto Meas

Related Functions

Auto Align

Remote Commands

DISPlay[:WINDow[1]]:TRACe:ALL[:SCALe][:AUTO]
 DISPlay[:WINDow[1]]:TRACe:X{:SCALe}:AUTO:SPAN
 DISPlay[:WINDow[1]]:TRACe:Y{:SCALe}:AUTO:PDIVision
 DISPlay[:WINDow[1]]:TRACe:ALL[:SCALe][:AUTO]:MARKer OFF | ON | 0 | 1

Auto Ranging (Amplitude Setup Panel)

When on, the auto ranging allows the OSA to achieve the desired sensitivity by taking several sweeps and switching between gain stages. The final trace data is a blended composite of each trace taken in the different gain stages.

Note The sweep time (ST) that is displayed in the lower portion of the display is the time that it takes for the OSA to sweep over one gain stage. The OSA may take up to three sweeps in three different gain stages to make the measurement. This depends on the settings for sensitivity, reference level, auto range and also the particular device being measured. The final data trace is a blended composite of each trace taken in the different gain stages. For more information, refer to "Sweep Time" on page 3-81.

Setting Auto Range to off will force the OSA to use a single gain stage and achieve the desired sensitivity by applying a digital filter.

Key Path Amplitude > Amplitude Setup > Auto Range

Remote Commands SENSE:POWer:DC:RANGe:AUTO

Auto Zero (Amplitude Setup Panel)

Turns Auto Zero on and off. Auto Zero on enables the internal amplifiers to be zeroed between sweeps. In this mode, the instrument compensates for temperature-related current drift between each sweep. Although this "zeroing" increases amplitude accuracy, it also increases the time between sweeps. If amplitude accuracy is not critical to your measurement, turning off auto zero will improve throughput. Pressing the front-panel Preset key resets this function to on.

Tip: The instrument performs a more complete zeroing when the instrument is first turned on. You can run this more complete routine anytime by pressing the Zero Now (System > More System Functions > Service Menu > Adv Service Functions > Zero Now) softkey.

Key Path Amplitude > Amplitude Setup > Auto Zero

Related Functions Zero Now

Remote Commands CALibration:ZERO

Averaging

When averaging is on, you can select the number of measurement sweeps to be averaged, using the 10, 20, 50, 100 softkeys. You can also enter averaging values other than those displayed by using the numeric keypad or the knob.

When the number of sweeps taken is less than the count, the following formula is used to calculate the data:

$$\text{AVG} = \text{sum of current sweeps} / \text{number of averages selected}$$

If the number of sweeps is greater than or equal to the count, the following formula is used to calculate the data:

$$\text{New average} = [(\text{count}-1)/\text{count}] \times \text{last average} + \text{new measurement}/\text{count}$$

Key Path

Traces > Averaging

Remote Commands

CALCulate[1 | 2 | 3 | 4 | 5 | 6]:AVERage:COUNT
CALCulate[1 | 2 | 3 | 4 | 5 | 6]:AVERage:STATe

Backup Internal Memory

Allows you to make a complete backup of user memory onto a floppy disk. All user files (measurement, trace, and specification sets) are saved. You can recall the backup contents into the instrument with the Restore Internal Memory function. Refer to "Backing Up or Restoring the Internal Memory" on page 2-19

A screen appears asking you to insert a formatted floppy disk into the floppy drive. The disk will not be viewable on a PC and no trace or measurement files can be saved onto the disk until it is reformatted. The backup internal memory function overwrites the floppy disk with a new image, so only the latest backup information can be recovered through the Restore Internal Memory operation. Any existing files or catalogs on the floppy disk will be destroyed.

Key Path

Save/Recall > Backup/Restore Menu > Backup Internal Memory

Backup/Restore Menu

Accesses the instrument utilities used to backup or restore internal memory.

Key Path Save/Recall > Backup/Restore Menu

Bandwidth Marker Interpolation (Marker Setup Panel)

Turns the bandwidth marker interpolation on or off. When on, the bandwidth markers will be placed at the exact number of dB (NDB) from the normal marker, if within the trace range. The position of the marker will be linearly interpolated between the two nearest trace data points. The default state is on. If interpolate is off, for negative number of dB (NDB) values, the bandwidth markers will be at values closest to and more negative than the NDB value. For positive NDB values, the bandwidth markers will be at values closest to and more positive than the NDB values. This will typically result in a wider bandwidth measurement.

Key Path	Markers > Marker Setup > Bandwidth Marker Interpolation
Related Functions	Active Marker, Delta Marker, Bandwidth Marker
Remote Commands	CALCulate[1 2 3 4 5 6]:MARKer[1 2 3 4]:FUNCTion:BANDwidth :INTerpolation

Bandwidth/Sweep

Accesses the menu that allows you to change bandwidth, sweep settings, fiber selection, trigger mode, and ADC sync. You can also access these functions from the Measure menu Bandwidth/Sweep selection. The function keys include:

- more BW/sweep functions
- repeat sweep
- res BW
- select fiber
- single sweep
- sweep time
- video BW

BW Marker Units (Marker Setup Panel)

Sets the bandwidth marker X-axis readout for frequency or wavelength when the instrument is in a non-zero span. The available selections are nm, μm , Ang, GHz, and THz. The default unit is nm (nanometers). This setting controls all four bandwidth markers. The normal and delta offset markers have their own settings.

Function Reference

Calibration

Key Path	Markers > Marker Setup > BW Marker Units
Related Functions	Marker BW
Remote Commands	CALCulate[1 2 3 4 5 6]:MARKer[1 2 3 4]:FUNCTion:BANDwidth:READout

Calibration

Accesses the Power Cal Setup and Wavelength Calibration Setup softkeys. The Power Calibration Setup panel will show the date of the last factory performed power calibration and the date of the last successful user-performed power calibration. It also allows you to set the calibration power and wavelength used for the next calibration. Refer to “Calibrating Wavelength Measurements” on page 2-13

Set Calibration Power is the exact amplitude of the calibration source that will be used for the next power calibration. The power entered must be within +10 dBm and –3 dBm of the amplitude measured using the factory calibration.

Set Calibration Wavelength is the approximate wavelength of the calibration source that will be used for the next user power calibration. The wavelength entered must be within 2.5 nm of the wavelength measured using the factory calibration.

Pressing the Perform Calibration softkey will display on-screen instructions for performing the calibration.

Key Path	Systems > Calibration
Remote Commands	CALibration:POWer:POWer CALibration:POWer:Wavelength

Calibrator Multi-Pt Align

Adjusts the mechanical position of the instrument’s internal optical components ensuring amplitude accuracy of your measurements. Before initiating the alignment, connect the internal calibrator to the front-panel input connector. Refer to “External Multipoint Wavelength Calibration” on page 2-16

The instrument automatically sets the start wavelength at 1490 nm, stop wavelength at 1590 nm, span, and reference level, and then performs a fully automatic, internal auto align. The input signal is aligned at equally spaced alignments (minimum 50 nm spacing between points) for the internal, multi-mode fiber or (minimum 5 nm spacing between points) for the external, single-mode fiber (Agilent 86146B only).

Note	Error 5056, Trajectory align cannot find input signal, will occur if a broadband light source is not connected to the front-panel input connector. Error 5060, Trajectory align failed, will occur if the align procedure failed.
Key Path	System > More System Functions > Service Menus > Adv Service Functions > More Adv Service Menu > Multi-Point Align > Calibrator Multi-Pt Align
Related Functions	Auto Align & Add To Trajectory Auto Align Preset User Source Multi-Pt Align
Remote Commands	CALibration:ALIGN:INTernal

Center Wavelength (WL)

Sets the center wavelength using the knob, step keys, or numeric keys. The span remains constant. The center wavelength and the start and stop wavelength settings are related as follows:

$$\text{Center Wavelength} = (\text{stop wavelength} + \text{start wavelength})/2$$

Key Path	Wavelength > Center WL
Related Functions	Start WL, Stop WL, Span
Remote Commands	SENSe:WAVelength:CENTer

Center Wavelength Step Size (Wavelength Setup Panel)

Specifies the center wavelength step size. This is used for incrementing center wavelength using the \uparrow and \emptyset keys.

Key Path Wavelength > Wavelength Setup > Center Wavelength Step Size

Remote Commands SENSE:WAVelength:CENTer:STEP:INCRement

Configure Network

Starts a utility that allows you to enable and configure networking. Enter this menu only if you have all the necessary networking parameters. Refer to "File Sharing and Printing over a Network" on page 2-25

Key Path System > More System Functions > GPIB & Network Setup > Configure Network

Current GPIB Address (Remote Setup Panel)

Displays the GPIB address currently being used. To change the address, use the numeric keys, step keys, or knob to enter the new GPIB address information in the Remote Setup panel.

Key Path System > More System Functions > GPIB & Network Setup > GPIB Address

Current Source Setup

Accesses the Current Source Setup panel that allows you to turn on or off the current source, set the current limit, enable pulse width, duty ratio, and synchronize the ADC sync output. Refer to "Operating the Internal White Light Source" on page 2-4

Key Path System > Options > Current Source Setup

Related Functions ADC sync, current limit, pulse width, duty ratio

Remote Commands SOURce:CURRent:PULSe:STATe ON|OFF

Date/Time (Display Setup Panel)

Turns the date and time on the display on or off. When on, the date and time will appear on the display's lower, right corner of the display and on printouts.

Key Path System > More System Functions > Display Setup

Related Functions SYSTem:TIMe

Default Math Trace C

Defines the math expression to be used and turns the math operation on: $C=A_{\text{LOG}}-B$, $C=A_{\text{LOG}}+B$, $C=A_{\text{LIN}}-B$, or $C=A_{\text{LIN}}+B$. The result is placed in Trace C. The math operation is performed in linear units.

See "Using Trace Math to Measure Wavelength Drift" on page 2-28.

Key Path Traces > Trace Math Off > Default Math Trace C

Remote Commands CALCulate3:MATH:STATE OFF|ON|0|1

Default Math Trace F

Defines the math expression to be used and turns the math operation on: $F=C_{\text{LOG}}-D$. The result is placed in Trace F. The math operation is performed in linear units.

See "Using Trace Math to Measure Wavelength Drift" on page 2-28.

Key Path Traces > Trace Math Off > Default Math Trace F

Remote Commands CALCulate6:MATH:STATE OFF|ON|0|1

Delete From (Delete Setup Panel)

Selects whether to delete a file from a floppy disk, internal memory, or a networked file share.

Key Path Save/Recall > Delete Menu > Delete File From

Remote Commands MMEMory:DElete

Delete Menu

Accesses the Delete Setup panel that allows you to delete files from a floppy disk, internal memory, or a networked file share.

Key Path Save/Recall > Delete Menu

Remote Commands MMEMory:DElete

Delta Marker On/Off

This toggle function fixes the position of the reference marker and activates the delta marker. This measures the difference between the active (reference) marker and the delta marker. The front knob, step keys, or keypad can be used to move the delta marker to the desired location. Refer to "Measuring the Difference between Traces" on page 2-27

If the delta function is turned on and no marker is active, Marker #1 will be turned on and placed at the center wavelength as a reference for the delta marker.

Note For Agilent 86146B only, if filter mode is enabled, the noise marker, delta marker, and OSNR marker are disabled.

Key Path Markers > More Marker Functions > Delta Marker

Remote Commands CALCulate[1 | 2 | 3 | 4 | 5 | 6]:MARKer[1 | 2 | 3 | 4]:FUNCTION:DELTA:STATE

Delta Marker Units (Marker Setup Panel)

Sets the delta marker X-axis readout for frequency or wavelength when the instrument is in a non-zero span. The available selections are nm, μm , Ang, GHz, and THz. The default units are nm (nanometers). This setting controls all four delta markers. The normal and bandwidth markers have their own settings.

Key Path	Markers > Marker Setup > Delta Marker Units
Related Functions	Delta Marker
Remote Commands	CALCulate[1 2 3 4 5 6]:MARKer[1 2 3 4]:FUNCTION:DELTA:X:READout

Display Mode

Accesses the choice of log (logarithmic) or lin (linear) data display.

Key Path	Amplitude > Display mode
Remote Commands	DISPlay:WINDow:TRACe:Y:SCALE:SPACing LINear LOGarithmic

Display Setup

Accesses the display setup panel selections which include:

- active function area assist
- Agilent logo
- date/time
- filter mode instrument panels
- path change instrument panel
- title

Function Reference

Display Setup

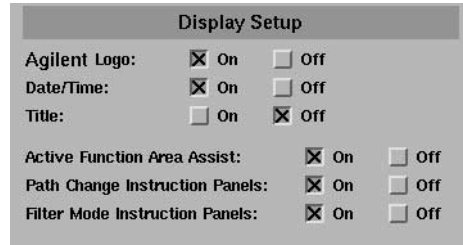

The Display Setup panel

Setup panel selections

Agilent Logo

When this function is ON, the Agilent logo is shown on the display and printouts.

Date/Time

Turns the date and time ON or OFF on the display.

Title

Turns the title ON or OFF on the display.

Active Function Area Assist

Automatically sets the Active Function Area (when function is turned on) to the first or top soft-key. For example, when you press the front-panel Bandwidth/Sweep key, the Active Function Area Assist function will set the Active Function Area to resolution bandwidth. This means you can immediately enter the desired resolution bandwidth. There is no need to press the *Res BW* softkey

Path Change Instructions Panels

For the Agilent 86146B Filter Mode only

Allows the choice of disabling the external path align setup instructions.

Filter Mode instruction Panels

For the Agilent 86146B Filter Mode only

Allows the choice of disabling the auto align, auto measure, and take sweep setup instructions.

Key Path

System > More System Functions > Display Setup

Remote Commands

DISPlay:WINDow:TEXT:DATA <string>

Exchange Menu

Accesses the trace exchange selections which include:

- A Exchange B
- B Exchange C
- C Exchange A
- D Exchange A
- E Exchange A
- F Exchange A

Exchanges the X- and Y-axis data of the two traces. The trace pairs that can be exchanged are Trace A with any trace, and Trace B with Trace C.

Key Path Traces > Trace Math > Exchange Menu

Remote Commands TRACe:EXCHange

Factory Preset (IP)

Performs an instrument preset and clears user settings that are not affected by Preset. That is, alignment settings, user calibration, multipoint amplitude correction data. User trace and measurement files will be maintained. See "Preset" on page 3-59.

Key Path System > More System Functions > Service Menu > Factory Preset (IP)

Related Functions Preset

Remote Commands CALibration:ALIGn:PRESet

Fast Meas Recall

Accesses the fast measure recall function that recalls the measurement state previously saved as FASTSAVE.dat in the internal memory by the Fast Measure Save function. Refer to "Recalling Data in Fast Meas Recall Mode" on page 2-23

Function Reference

Fast Meas Save

Key Path Save/Recall > Fast Meas Recall

Related Functions Recall, Fast Meas Save

Fast Meas Save

Accesses the fast measure save function to save the current measurement state to internal memory as FASTSAVE.dat. Allows a quick save of the current state, which can then be recovered by the Fast Meas Recall function. Only one FASTSAVE.dat file exists, so performing a Fast Meas Save will overwrite any currently existing Fast Save file. Refer to “Saving Data in Fast Meas Save Mode” on page 2-19

Key Path Save/Recall > Fast Meas Save

Related Functions Save, Fast Meas Recall

File Name (Save Setup Panel)

Selects automatic or manual mode for saving a filename.

When Auto is selected, the measurement is automatically named and saved to an auto generated filename when the Auto Save softkey is pressed. Measurement data is saved to the filename ST_XXXX.dat and Trace(s) only is saved to the filename TR_XXXX.csv. “XXXX” represents a numbering system which is incremented each time the measurement data is saved. For example, the first time you save Trace(s) only data, the filename TR_00001.csv will be assigned.

When Manual is selected, pressing the Choose File to Save softkey will access the Filename Menu setup panel. Use the front panel step keys, knob, or arrow softkeys to highlight and then select each letter in the filename. Filenames can also be set with an external keyboard, Refer to “Entering a Filename using an External Keyboard” on page 2-22. When you finish entering the filename, press SAVE FILE.

Key Path Save/Recall > Save Menu > File Name

Remote Commands *SAV

File Shares

Uses the LAN (local area network) to store, recall, and delete files on remote hard drives. The data can then be accessed and shared among the users.

To access the file and printer share softkeys, you must first configure the network refer to "Connecting to the OSA over the Network" on page 4-6 and enter the user share identity/user profile information for remote shares (refer to "File Sharing and Printing over a Network" on page 2-25). The softkeys for file and printer share will then become available for selection.

Note

Samba[®] or Microsoft[®] software must be installed to run the file share programs.

Note

If networking is not configured, the command will generate a "Settings conflict" error.

Key Path

Systems > More System Functions > GPIB & Network Setup > File Shares

Related Commands

Printer Share

Remote Commands

SYSTem:COMMunicate:NETWork:USERname <param>
 SYSTem:COMMunicate:NETWork:PASSword <param>
 SYSTem:COMMunicate:NETWork:WORKgroup <param>

Filter Marker Tune

For Agilent 86146B Filter Mode only.

Tunes the wavelength of the preselector. During the preselector instrument mode, the instrument acts as an optical filter at a fixed wavelength. Although the instrument is not sweeping the displayed input range, the last sweep remains displaying the input spectrum. With filter marker tune softkey selected, use the front panel knob, step keys, or numeric keypad to change the preselector wavelength. Press Take Sweep to update the displayed response at any time.

The amount of filtering is determined by the resolution bandwidth setting. Narrower resolution bandwidth settings will filter the signal more. If the resolution bandwidth is changed, Filter Marker Tune must be reselected to tune the monochromator. Marker movement will not tune the monochromator unless Marker Tune is active.

The front panel, single mode preselector monochromator connector allows the channel drop capability to the Agilent 86130A BitAnalyzer error performance analyzer or the Agilent 86100A Infinium digital communication analyzer.

Function Reference

Filter Mode

Note	During filter mode, the noise marker, delta marker, and OSNR marker are disabled.
------	---

Key Path	Appl's > Measurement Modes > Filter Mode > Switch Path Auto Align Now or Switch Path No Auto Align > Filter Marker Tune
----------	---

Remote Commands	CALCulate[1 2 3 4 5 6]:MARKer:SRLevel INPut:FILTer:SCENt INPut:FILTer:SRLevel
-----------------	---

Filter Mode

For the Agilent 86146B Filter Mode only.

The filter mode utilizes the 9 μm external optical path to increase dynamic range and resolution bandwidth with the Agilent 86146B filter mode. An active tuning marker can be selected and tuned to the wavelength position. The filter marker becomes the current marker and has the active area focus. All other markers stay on. Refer to "Analyzing Measurement Data" on page 2-26 for further information. Also see "Time Resolved Chirp" on page 2-34

Key Path	Appl's > Measurement Modes > Filter Mode
----------	--

Remote Commands	INSTrument:SElect "FILTER"
-----------------	----------------------------

Filter Mode Instruction Panels

For the Agilent 86146B Filter Mode only

Allows the choice of disabling the auto align, auto measure, and take sweep setup instructions when switching from internal to external path.

Key Path	System > More System Functions > Display Setup > Filter Mode Instrument Panels
----------	--

Firmware Upgrade

The instrument will restart into a utility to upgrade the instrument firmware. For upgrade instructions, or to order a firmware upgrade kit, visit our web site at <http://www.agilent.com/comms/osaupgrade>

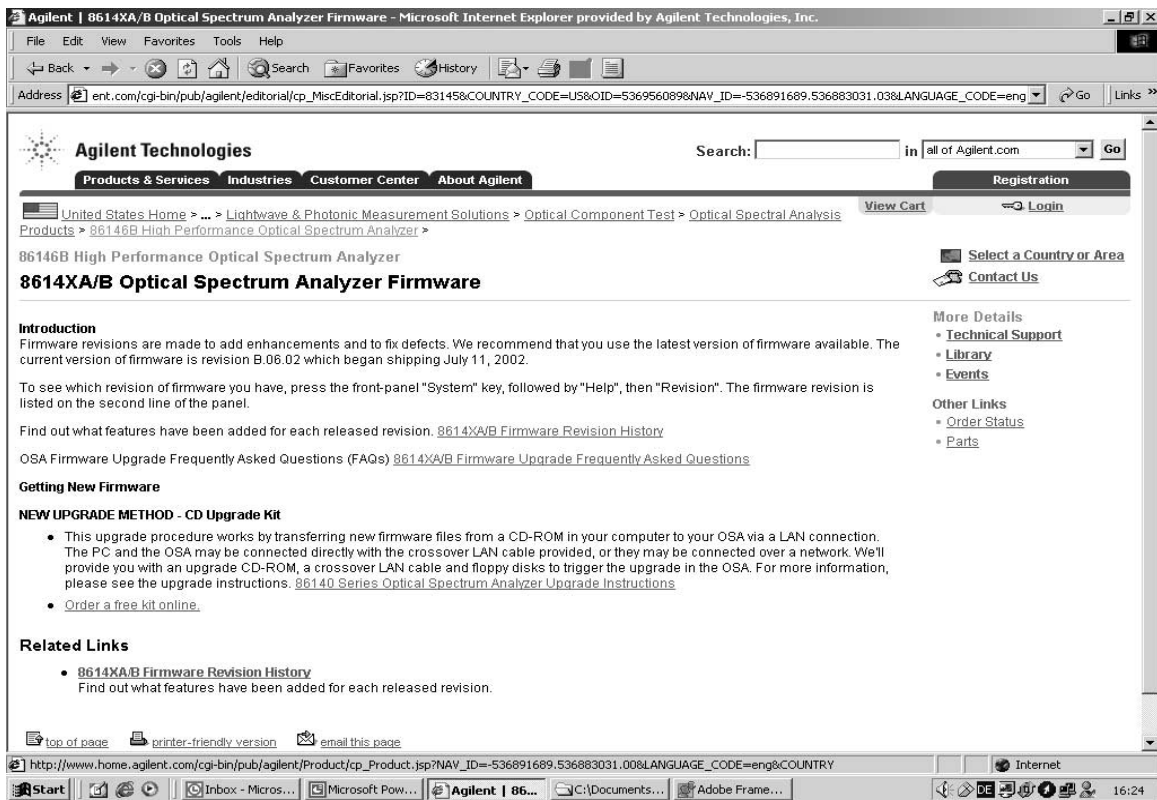

Key Path

System > More System Functions > Service Menu > Firmware Upgrade

Format Floppy Disk

Formats a 3.5, 1.44 MB floppy disk. The instrument does not support formatting 2.0 MB floppy disks. Refer to "Saving, Recalling, and Managing Files" on page 2-18

Function Reference

GPIB Address

Key Path Save/Recall > Format Floppy Disk

GPIB Address

Accesses the GPIB address information. To change the address, use the numerical entry keys, step keys, or knob to enter the new GPIB address information. If changes are made, press the Select softkey. Press the Defaults softkey to reset the address to the factory preset default, 23.

Key Path System > More System Functions > GPIB Address & Network Setup > GPIB Address

GPIB & Network Setup

Accesses the functions used to set up networked file and printer shares on the analyzer.

- GPIB Address
- Configure Network
- User Share Identity
- File Shares
- Printer Shares

Key Path System> More System Functions > GPIB Address & Network Setup

Help

Accesses error queues for: hardware errors, critical errors, notices, and warnings once an error queue is accessed. Also displays the instrument's current firmware revision. Refer to "Firmware Upgrade" on page 3-27. You can print the queue, clear the queue, or page up and down to view the information. If no hardware errors, critical errors, notices, or warnings have been generated, these functions will be shaded.

Key Path System > Help

Remote Commands SYSTem:ERRor?
 *IDN?

Hold A...F None Min Max (trace)

Hold Max compares the current amplitude value of each point on the active trace in the current sweep to the corresponding point detected during the previous sweep, then displays the maximum value.

Hold Min compares the current amplitude value of each point on a trace in the current sweep to the corresponding point detected during the previous sweep, then displays the minimum value.

Hold None turns the Hold function off.

Key Path	Traces > Hold None Min Max
Remote Commands	CALCulate[1 2 3 4 5 6]:MAXimum:STATe CALCulate[1 2 3 4 5 6]:MINimum:STATe

Integrate Limit

Calculates the power between Wavelength Marker 1 and Wavelength Marker 2 when the trace integration function is on.

Once wavelength markers have been turned on, the total power integration marker search, and wavelength sweep may be individually limited to the wavelength marker range.

Key Path	Markers > More Marker Functions > Line Marker Menu > Advanced Line Mkr Functions > Integrate Limit
Related Functions	Sweep Limit, Search Limit
Remote Commands	CALCulate:TPOWer:IRANge:LOWer CALCulate:TPOWer:IRANge:UPPer

Light Source

Turns the desired light source on or off. The number and type of sources displayed depends on the options installed. Refer to "Operating the Internal White Light Source" on page 2-4

Function Reference

Line Marker Menu

Key Path System > Options > Light Source

Related Functions Current Source Setup

Remote Commands SOURce:CATalog
 SOURce:STATe

Line Marker Menu

Accesses the following line marker functions:

- Advanced Line Mkr Functions
- Line Markers Off
- Wavelength Line Mkr 1
- Wavelength Line Mkr 2

Key Path Markers > More Marker Functions > Line Marker Menu

Line Markers Off

Turns off all line markers and line marker functions.

Key Path Markers > More Marker Functions > Line Marker Menu > Line Markers Off

Remote Commands CALCulate[1 | 2 | 3 | 4 | 5 | 6]:MARKer[1 | 2 | 3 | 4]:SRANge:OFF

Lin Math C=A-B

Subtracts Trace B from Trace A point by point, then stores the results in Trace C in linear units. If Trace A is in View On mode, this function is continuous and occurs every sweep. Results of the subtraction are referenced to 0 dB. This often requires a reference level adjustment. For example, if the reference level is set at -40 dBm, Trace A is at -50 dBm, and Trace B is at -55 dBm, the C=A-B function places Trace C at -5 dB. Because this is off screen, the reference level will need to be adjusted.

Key Path	Traces > Trace Math OFF > Default Math Trace C > Lin Math C=A-B
Remote Commands	CALCulate3:MATH:EXPRession(TRA-TRB)

Lin Math C=A+B

Adds Trace A and Trace B point by point, then stores the results in Trace C in linear units. The results of this function often require a reference level adjustment. Trace A is placed in View On mode. Trace math is mainly used to normalize the display during stimulus-response measurements.

Key Path	Traces > Trace Math OFF > Default Math Trace C > Lin Math C=A+B
Remote Commands	CALCulate3:MATH:EXPRession(TRA+TRB)

Local

Restores front-panel control of the instrument. Whenever the instrument is in Remote mode, the RMT message is displayed on the instrument's screen and all keys are disabled except for the front-panel Local key.

Key Path	Local
Remote Commands	GPIB GoTo Local Command

Log Math C=A-B

Subtracts Trace B from Trace A point by point, then stores the results in Trace C in logarithmic units. If Trace A is in View On mode, this function is continuous and occurs every sweep. Results of the subtraction are referenced to 0 dB. This often requires a reference level adjustment. For example, if the reference level is set at -40 dBm, Trace A is at -50 dBm, and Trace B is at -55 dBm, the C=A-B function places Trace C at -5 dB. Because this is off screen, the reference level will need to be adjusted.

Key Path	Traces > Trace Math OFF > Default Math Trace C > Log Math C=A-B
----------	---

Function Reference

Log Math C=A+B

Related Functions Log Math C=A+B, Log Math F=C-D

Remote Commands CALCulate3:MATH:EXPRession(TRA/TRB)

Log Math C=A+B

Adds Trace A and Trace B point by point, then stores the results in Trace C in logarithmic units. The results of this function often require a reference level adjustment. Trace A is placed in View On mode. Trace math is mainly used to normalize the display during stimulus-response measurements.

Key Path Traces > Trace Math OFF > Default Math Trace C > Log Math C=A+B

Related Functions Log Math C=A-B, Log Math F=C-D

Remote Commands CALCulate3:MATH:EXPRession(TRA*TRB)

Log Math F=C-D

Subtracts Trace D from Trace C point by point, then stores the results in Trace F in logarithmic units. If Trace C is in View On mode, this function is continuous and occurs every sweep. Results of the subtraction are referenced to 0 dB. This often requires a reference level adjustment. For example, if the reference level is set at -40 dBm, Trace D is at -50 dBm, and Trace C is at -55 dBm, the F=C-D function places Trace F at -5 dB. Because this is off screen, the reference level will need to be adjusted.

Key Path Traces > Trace Math OFF > Default Math Trace F > Log Math F=C-D

Related Functions Log Math C=A-B, Log Math C=A+B

Remote Commands CALCulate6:MATH:EXPRession(TRC/TRD)

Marker BW

Measures the passband of the signal. To enter the bandwidth amplitude of the bandwidth markers, make a selection from the softkeys (-3 dB, -6 dB, -10 dB, and -20 dB) or use the knob, step keys, or numeric keys. Marker bandwidth information is displayed at the top of the graticule.

If a peak search is not performed, then pressing Marker BW finds the bandwidth around the currently active marker. If the bandwidth markers cannot be placed at the selected value, an error message, such as "BW not found" will be displayed.

See "Using Span to Zoom In" on page 2-7.

Key Path	Markers > More Marker Functions > Marker BW
Related Functions	Peak Search
Remote Commands	CALCulate[1 2 3 4 5 6]:MARKer[1 2 3 4]:FUNctioN:BANDwidth:STATe CALCulate[1 2 3 4 5 6]:MARKer[1 2 3 4]:FUNctioN:BANDwidth:INTerpolate (-0.5 dB -3 dB -6 dB -10 dB -20 dB) CALCulate[1 2 3 4 5 6]:MARKer[1 2 3 4]:FUNctioN:BWIDwidth:NDB CALCulate[1 2 3 4 5 6]:MARKer[1 2 3 4]:FUNctioN:BANDwidth:RESult?

Marker Off

Turns the current active marker off.

Key Path	Markers > Active Marker > Marker Off
Remote Commands	CALCulate[1 2 3 4 5 6]:MARKer[1 2 3 4]:STATe OFF CALCulate[1 2 3 4 5 6]:MARKer[1 2 3 4]:AOFF

Marker Search Menu

Accesses the following marker peak and pit search functions:

- peak or pit search mode
- peak or pit search
- next peak down, left or right
- next pit up, left or right
- active markers

The active markers can also be turned on or off from this menu, which avoids returning to the Marker menu to change markers.

Key Path Markers > More Marker Functions > Marker Search Menu

Marker Search Threshold Value (Marker Setup Panel)

Sets the amplitude threshold value used for limiting the marker search function. Any peaks below the threshold value will be ignored. When the Marker Search Threshold is on, a dotted line is shown on the display at the threshold level. The Use Marker Search Threshold function in the Marker Setup Panel must be enabled or the Marker Search Threshold Value will be greyed out.

Key Path Markers > Marker Setup > Marker Search Threshold Value

Related Functions Pit Excursion, Peak Excursion, Marker Search Threshold

Remote Commands CALCulate:THReshold
CALCulate:THReshold:STATe

Marker Setup

Accesses a menu that allows you to make changes to default marker settings. From the setup panel you can make changes to:

- Bandwidth/Marker Interpolation On | Off
- BW Marker Units
- Delta Marker Units
- Marker Search Threshold Value
- Noise Marker Reference Bandwidth
- Normal/Delta Marker Interpolation On | Off
- Normal Marker Units
- OSNR Noise
- Peak Excursion
- Peak Search at End of Each Sweep On | Off
- Pit Excursion
- Use Marker Search Threshold



The Marker Setup panel

Function Reference

Marker Setup

Setup Panel Selections

Normal Marker Units

Sets the X-axis immediately displayed marker information for frequency or wavelength when the instrument is in a non-zero span. This setting controls only the normal marker X-axis and the delta reference immediately displayed information. This setting controls all four normal markers. The bandwidth and delta offset markers have their own settings.

BW Marker Units

Sets the bandwidth marker X-axis immediately displayed information for frequency or wavelength when the instrument is in a non-zero span. The delta markers have their own setting. This setting controls all four bandwidth markers.

Delta Marker Units

Sets the delta marker X-axis immediately displayed information for frequency or wavelength when the instrument is in a non-zero span. The bandwidth markers have their own setting. This setting controls all four delta markers.

Normal/Delta Marker Interpolation

Turns the normal/delta marker interpolation on or off. When interpolation is ON, the normal/delta markers will be placed at the exact wavelength or frequency value selected if it is within the trace range. The marker will linearly interpolate between two trace data points. The default state is off. This setting controls the interpolation state for all four markers when in the normal or delta mode. When interpolation is off, the marker will be placed at the trace point nearest the requested value.

Bandwidth Marker Interpolation

Turns the bandwidth marker interpolation on or off. When interpolation is ON, the bandwidth markers will be placed at the exact number of dB (NDB) from the normal marker if within the trace range. The position of the marker will be linearly interpolated between two trace data points. The default state is ON. If interpolate is OFF, for negative NDB values, the bandwidth markers will be at values closest to and more negative than the NDB value. For positive NDB values, the bandwidth markers will be at values closest to and more positive than the NDB values. This will typically result in a wider bandwidth measurement.

Peak Excursion

Determines (in dB) which side modes are included in the measurements. To be accepted, each trace peak must rise, and then fall, by at least the peak excursion value about a given spectral component. The default value is 3 dB. Setting the value too high may result in not identifying a side mode. Setting the value too low may cause unwanted responses, including noise spikes, to be identified. Use the Marker Setup panel to change the peak excursion value.

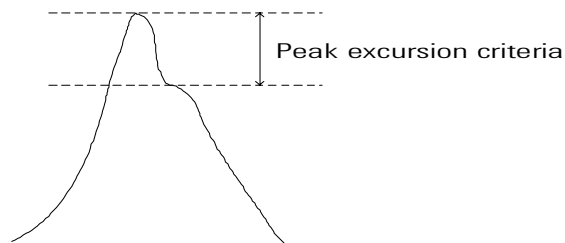

Changing the peak excursion. The peak searches may not recognize valid signals near the noise floor when the peak excursion definition is less than 3 dB. Thus, before performing peak searches on signals near the noise floor, reduce the peak excursion value. However, reducing the excursion value often causes peak searches to identify noise spikes. To avoid this misidentification, use video averaging or video filtering to reduce the noise floor variance to a value less than the peak excursion definition.

Pit Excursion

Sets the pit excursion value for the marker search routines.

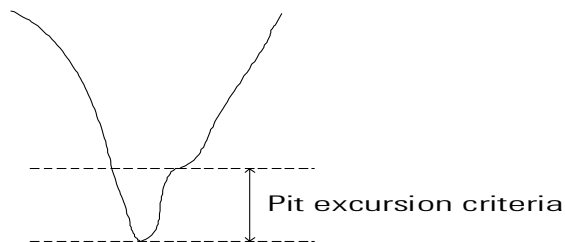

The pit excursion value is used to determine whether or not a local minimum in the trace is to be considered a pit. To qualify as a pit, both sides of the local minimum must rise by at least the pit excursion value.

Changing the pit excursion. The pit searches may not recognize valid signals near the noise floor when the pit excursion definition is less than 3 dB. Thus, before performing pit searches on signals near the noise floor, reduce the pit excursion value. However, reducing the excursion value

Function Reference

Marker Setup

often causes pit searches to identify noise spikes. To avoid this misidentification, use video averaging or video filtering to reduce the noise floor variance to a value less than the pit excursion definition.

Use Marker Search Threshold

This limits the marker search function to data points above the selected threshold level. When Marker Search Threshold is ON, a dotted line is shown on the display at the threshold level.

Marker Search Threshold Value

Selects the amplitude threshold value used for limiting the marker search function.

Noise Marker Reference Bandwidth

Sets the normalization bandwidth for the noise and OSNR marker. There are two allowable settings: 1 nm and 0.1 nm.

Note

Changing this value will change the value of the noise marker by 10 dB.

Peak Search at End of Each Sweep

Finds the peak value of the trace and moves the active marker to the peak at the end of each sweep. This function operates on the normal, delta, bandwidth, noise markers, and OSNR.

OSNR Noise

Determines how the noise markers are to be calculated, Pit, Auto, or Manual. The default is Auto mode.

- Pit: Uses the pit excursion criteria to find the closest pits from the center marker. Noise markers will be placed at the two pits.
- Auto: Uses a fixed offset, coupled with the resolution bandwidth, from the center marker.

RBW/2 +5nm

- Manual: Uses a user specified fix offset from the center marker. The default value is 0.4 nm and the step size is 0.2 nm when using the step keys. This field is inactive when set to Auto or Pit.

Key Path

Markers > Marker Setup

Marker to Center

Changes the center wavelength to the wavelength of the active marker.

Key Path Markers > Marker to Center

Remote Commands CALCulate[1 | 2 | 3 | 4 | 5 | 6]:MARKer[1 | 2 | 3 | 4]:SCENter

Marker to Ref Level

Changes the reference level to the amplitude of the active marker.

Key Path Markers > Marker to Ref Level

Remote Commands CALCulate[1 | 2 | 3 | 4 | 5 | 6]:MARKer:SRLevel

Markers

Accesses a menu that allows you to select and control trace markers. The Markers keys can be accessed using the front panel Markers key or the Measure menu Markers selection.

See “Tips for Using Traces and Markers” on page 2-26, “Tips for Using Traces and Markers” on page 2-26, and “Using Trace Math to Measure Wavelength Drift” on page 2-28.

Measurement Mode

For Agilent 86146B only
Accesses filter mode and power meter mode.

Key Path	Appl's > Measurement Modes
Related Functions	Filter mode, Power Meter mode
Remote Commands	INSTrument:NSElect INSTrument:SElect

More Marker Functions

Accesses the following marker search functions:

- delta marker
- marker BW
- marker search menu
- OSNR marker
- noise marker

Key Path	Markers > More Marker Functions
----------	---------------------------------

More System Functions

Accesses the following functions:

- auto measure setup
- display setup
- GPIB & network setup
- service menu
- set time/date
- state info

Key Path	System > More System Functions
----------	--------------------------------

Move Active Area

Moves the active function area to one of eight on-screen locations. To change the active function area location, press the Move Active Area softkey until you are satisfied with the position.

Key Path System > Move Active Area

Move Power Display Area

For Agilent86146B only

Moves the power meter mode display area to one of eight on-screen locations.

Key Path Appl's > Measurement Modes > Power Meter Mode > Move Power Display Area

Remote Commands DISPlay{:WINDow[1]]:POPop[1 | 2 | 3 | 4][:ALL] OFF | ON1 | 2

Multi-Point Align

Accesses the internal, external, and multi-point alignment functions:

- auto align & add to trajectory
- auto align preset
- calibrator multi-pt align
- marker tune
- user source multi-pt align

See "Auto Align" on page 3-9

Key Path System > More System Functions > Service Menu > Adv Service Functions > More Adv Service Menu > Multi-Point Align

New GPIB Address (Remote Setup Panel)

Allows you to enter a new GPIB address. To change the address, use the numeric entry keys, step keys, or knob. Press the Defaults softkey to reset the address to the factory preset default, 23.

Key Path System > More System Functions > GPIB & Network Setup > GPIB Address

Related Functions Current GPIB Address

Next Peak Down

Places the active marker on the next highest peak down from the current marker amplitude. This peak must meet the peak excursion and threshold criteria. If the specified marker is off, it will be turned on and placed at the center wavelength. The search for the next maximum will reference that point.

Key Path Markers > More Marker Functions > Marker Search Menu > Next Peak Down

Remote Commands :CALCulate[1 | 2 | 3 | 4 | 5 | 6]:MARKer[1 | 2 | 3 | 4]:MAXimum:NEXT

Next Peak Left

Places the marker on the next peak located at a lower X-axis value (usually wavelength) than the current marker position. This peak must meet the peak excursion and threshold criteria. If the specified marker is off, it will be turned on and placed at the center wavelength or frequency.

Key Path Markers > More Marker Functions > Marker Search Menu >Next Peak Left

Remote Commands :CALCulate[1 | 2 | 3 | 4 | 5 | 6]:MARKer[1 | 2 | 3 | 4]:MAXimum:LEFT

Next Peak Right

Places the marker on the next peak located at a higher X-axis value (usually wavelength) than the current marker position. This peak must meet the peak excursion and threshold criteria. If the specified marker is off, it will be turned on and placed at the center wavelength or frequency.

Key Path Markers > More Marker Functions > Marker Search Menu > Next Peak Right

Remote Commands :CALCulate[1 | 2 | 3 | 4 | 5 | 6]:MARKer[1 | 2 | 3 | 4]:MAXimum:RIGHT

Next Pit Left

Places the marker on the next pit located at a lower X-axis value (usually wavelength) than the current marker position. This pit must meet the pit excursion and threshold criteria. If the specified marker is off, it will be turned on and placed at the center wavelength or frequency.

Key Path Markers > More Marker Functions > Marker Search Menu > Next Pit Left

Remote Commands :CALCulate[1 | 2 | 3 | 4 | 5 | 6]:MARKer[1 | 2 | 3 | 4]:MINimum:LEFT

Next Pit Right

Places the marker on the next pit located at a higher X-axis value (usually wavelength) than the current marker position. This pit must meet the pit excursion and threshold criteria. If the specified marker is off, it will be turned on and placed at the center wavelength or frequency.

Key Path Markers > More Marker Functions > Marker Search Menu > Next Pit Right

Remote Commands :CALCulate[1 | 2 | 3 | 4 | 5 | 6]:MARKer[1 | 2 | 3 | 4]:MINimum:RIGHT

Next Pit Up

Places the active marker on the next lowest pit from the current marker amplitude. This pit must meet the pit excursion and threshold criteria. If the specified marker is off, it will be turned on and placed at the center wavelength. The search for the next minimum will reference that point.

Key Path Markers > More Marker Functions > Marker Search Menu > Next Pit Up

Remote Commands CALCulate[1 | 2 | 3 | 4 | 5 | 6]:MARKer[1 | 2 | 3 | 4]:MINimum:NEXT

Noise Marker

Measures the spectral power density at the position of the active marker. The measurement is referenced to 0.1 nm or 1.0 nm reference bandwidth. The reference bandwidth used to normalize the noise is selected on the marker setup panel.

Note For Agilent 86146B only, if filter mode is enabled, the noise marker, delta marker, and OSNR marker are disabled.

Key Path Markers > More Marker Functions > Noise Marker

Related Functions Active Marker

Remote Commands CALCulate:MARKer:FUNCTion:NOISe:STATe OFF | ON | 0 | 1

Normal/Delta Marker Interpolation (Marker Setup Panel)

Turns the normal/delta marker interpolation on or off. When on, the normal/delta markers will be placed at the exact wavelength or frequency value selected if it is within the trace range. The marker will linearly interpolate between two trace data points. When off, the marker will be placed on the nearest trace data point.

This setting enables interpolation for all four markers when in normal or delta mode.

Key Path Markers > Marker Setup > Normal/Delta Marker Interpolation

Related Functions	Active Marker, Delta Marker
Remote Commands	CALCulate[1 2 3 4 5 6]:MARKer[1 2 3 4]:INTerpolation

Normal Marker Units (Marker Setup Panel)

Sets the marker X-axis readout for frequency or wavelength when the instrument is in a non-zero span. The X-axis default units is nm (nanometers). This setting controls only the normal marker X-axis readout and the delta reference readout. This setting controls all four normal markers. The bandwidth and delta offset markers have their own setting.

Key Path	Markers > Marker Setup > Normal Marker Units
Related Functions	Active Marker
Remote Commands	CALCulate[1 2 3 4 5 6]:MARKer[1 2 3 4]:X:READout

OSNR Marker

Indicates the signal quality based on the signal strength and noise level. Turning on the OSNR marker will display four markers: an active marker, a center marker, and two noise markers. To adjust the active marker to the desired measurement location, use the step keys, knob, or keyboard. The center marker is positioned at the closest peak to the active marker. The location of the noise markers is determined by the selection of the Noise Method and the center marker. The noise measurement is referenced to 0.1 nm noise resolution bandwidth.

Function Reference
OSNR Marker

Note For Agilent 86146B only, if filter mode is enabled, the noise marker, marker BW, delta marker, and OSNR marker are disabled.

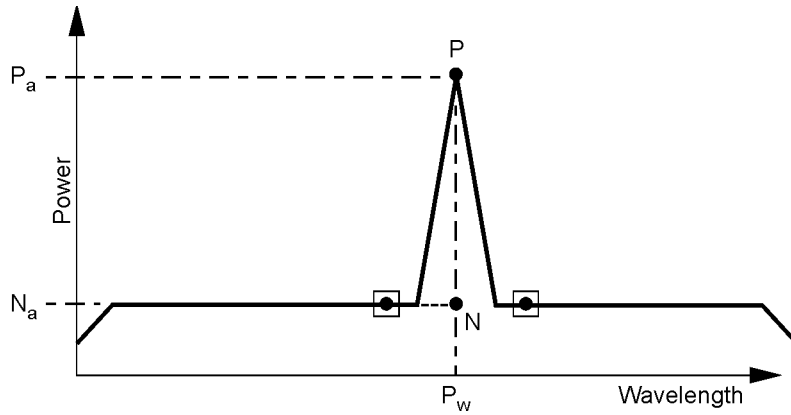

= noise marker symbols

N = interpolated noise

N_a = interpolated noise amplitude

P = peak

P_a = peak amplitude

P_w = center wavelength

Center amplitude = $P_a - N_a$

OSNR = Center amplitude / N_a (normalized)

Interpolating Noise

To accurately measure noise, the noise level must be determined at the signal wavelength. The measurement cannot be directly performed because the signal power level masks the noise. To estimate the noise at the signal wavelength, the OSA measures the noise power above and below the channel wavelength at the predetermined offset or pits (depending on the Noise Method selected in the Marker Setup panel). Next, the values are linearly interpolated to determine the noise value at the channel wavelength.

Error Messages

OSNR error messages are displayed in red letters and are described below with suggestions to correct the error.

Noise Not Found can be displayed for two different conditions. The first condition occurs when Pit mode is selected, and the left or right marker is unable to find a pit using the Pit Excursion (selected in the Marker Setup panel).

The second condition occurs when auto or manual mode is selected and the left or right marker is outside the span. In this case, the noise measurement is made at the span's end point.

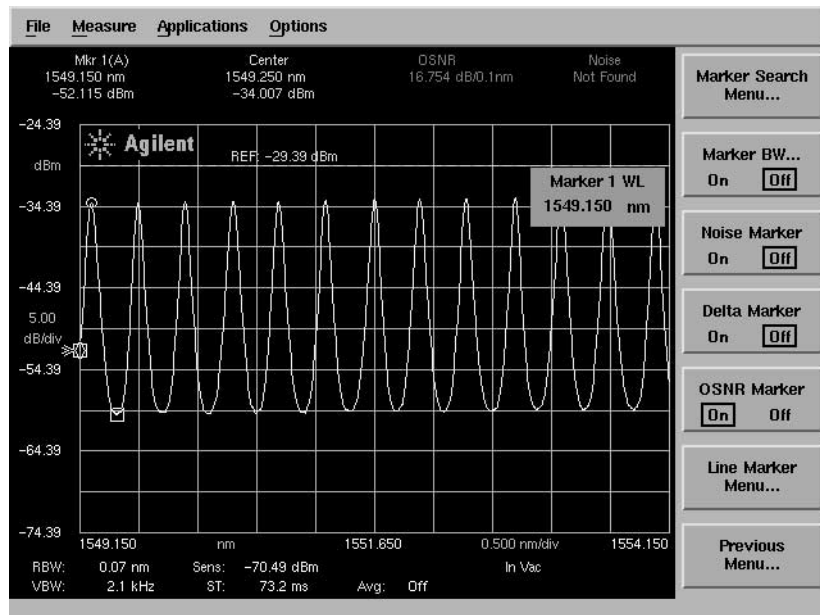

Noise Not Found error message

Tip: If this error occurs, decrease the pit excursion (when you are in pit mode), increase the span (when you are in auto or manual mode), or select manual (when you select auto mode) to adjust the offset.

Center Not Found and OSNR Not Valid occurs if no signal or peaks are found.

OSNR Not Found occurs if the noise level is higher than the signal level.

Tip: If no signal or no peaks are found error occurs, reduce the peak excursion and/or threshold values. If the noise level is higher than the signal level, change to Pit Mode or manually adjust the offset.

Function Reference
OSNR Marker

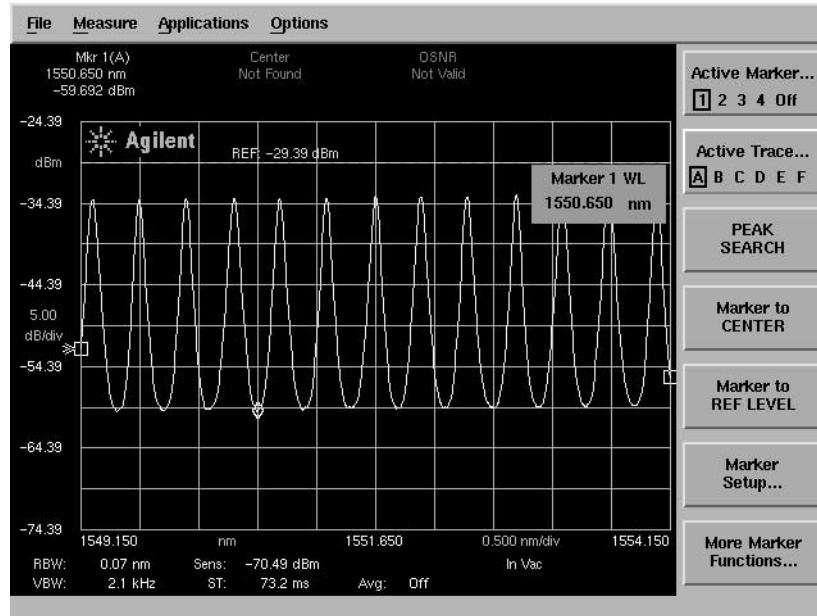

Center Not Found error message

Key Path

Markers > More Marker Functions > OSNR Marker

Remote Commands

```
CALCulate[1 | 2 | 3 | 4 | 5 | 6]:MARKer[1 | 2 | 3 | 4]:FUNCTION:OSNR[:STATe]  
OFF | ON | 0 | 1
```

Options

Accesses the Current Source Setup and Light Source Output Setup softkeys.

Current Source Setup panel allows you to set the current limit, enable pulse mode and synchronize the ADC sync output. See "Current Source Setup" on page 3-18

Light Source panel turns the desired light source on or off. The number and type of sources displayed depends on the options installed. See "Light Source" on page 3-29

Key Path System > Options

Remote Commands SOURce[n]:STATe

OSA Extended State Information

Displays the OSA extended state information:

- Align Pos (Internal)
- Align X (Internal)
- Align Y (Internal)
- Amp Corr
- Grat Offset
- Grating Order
- Hi Gain TransZ amplifier stage value
- Line Spacing
- Lo Gain TransZ amplifier stage value
- S1
- Trajectory alignment Data (Internal)

Key Path System > More System Functions > Service Menu > Adv Service Functions > More Adv Service Menu > Extended State Info

OSA State

Displays the state information. The state information includes:

- center wavelength
- model #
- options
- serial #
- software revision
- span
- start wavelength
- stop wavelength
- wavelength offset
- wavelength step

You can print this information using the internal or external printer.

Key Path

System > More System Functions > OSA State

Path Change Instruction Panels

For the Agilent 86146B Filter Mode only

Allows the choice of disabling the external path align setup instructions. Refer to "Switch Path Auto Align Now" on page 3-82 and to "Switch Path No Auto Align" on page 3-83.

Key Path

System > More System Functions > Display Setup

Peak to Center

Finds the highest amplitude trace point and sets the center wavelength to that wavelength.

Key Path	Wavelength > Peak to Center
Remote Commands	CALCulate[1 2 3 4 5 6]:MARKer[1 2 3 4]:MAXimum CALCulate[1 2 3 4 5 6]:MARKer[1 2 3 4]:SCENter SENSe:WAVelength:CENTer

Peak Excursion (Marker Setup Panel)

Sets the peak excursion value for the marker search functions.

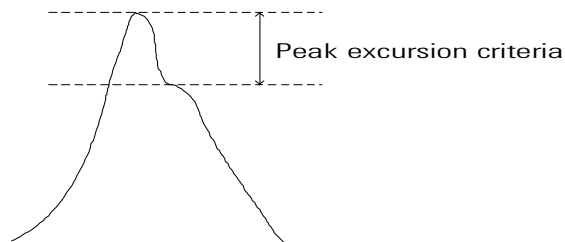

For marker search functions, a signal peak is defined as a rise and fall in the displayed response by at least the peak excursion value. If peak excursion is set too high, legitimate peaks may not be discerned as signals. With lower values more signals will be discerned, but peaks in the noise floor may also be discerned as signals. To reduce the noise floor variance to a value less than the peak excursion rate, try using video averaging and/or lowering the sensitivity.

Key Path	Markers > Marker Setup > Peak Excursion
Related Functions	Marker Search Threshold, Next Peak Down \emptyset , Next Peak Right Æ , Next Peak Left ⌂
Remote Commands	CALCulate[1 2 3 4 5 6]:MARKer[1 2 3 4]:PEXCursion:PEAK

Peak Search

Places a marker on the highest amplitude trace point. If no marker is on, Marker #1 will be used for the peak search.

Next Peak Down

Places the marker on the next highest peak from the current marker amplitude. This next highest peak must meet the peak excursion and threshold criteria. If the specified marker is OFF, it will be turned ON, placed at the center wavelength, and the search for the next maximum will begin from that point.

Next Peak Left

Places the marker on the next peak located at a shorter wavelength than the current marker wavelength position. This next peak must meet the peak excursion and threshold criteria. If the specified marker is OFF, it will be turned ON, placed at the center wavelength, and the search to the left will begin from that point.

Next Peak Right

Places the marker on the next peak located at a longer wavelength than the current marker wavelength position. This next peak must meet the peak excursion and threshold criteria. If the specified marker is OFF, it will be turned ON, placed at the center wavelength, and the search to the right will begin from that point.

Active Marker...

Turns a particular marker ON or OFF. Turning a marker OFF will turn off any marker function that was on for that particular marker. When the marker is turned ON again, all the marker functions for that marker will be off.

The active marker is placed on the highest point of the active trace. If no marker is ON, Marker #1 will be turned ON and placed on the highest point of the active trace.

Note

For addition information on setting the peak and pit excursion criteria, see "Peak Excursion" and "Pit Excursion" on page 3-37.

See "Tips for Using Traces and Markers" on page 2-26

Key Path Markers > Peak Search
 Markers > More Marker Functions > Marker Search Menu > Search Mode Peak > Peak Search

Remote Commands CALCulate[1 | 2 | 3 | 4 | 5 | 6]:MARKer[1 | 2 | 3 | 4]:MAXimum

Peak Search at End of Each Sweep (Marker Setup Panel)

Finds the peak value of the trace and moves the active marker to the peak at the end of each sweep. This function operates on normal, delta, and bandwidth markers.

Key Path Markers > Marker Setup > Peak Search at End of Each Sweep

Remote Commands CALCulate[1 | 2 | 3 | 4 | 5 | 6]:MARKer[1 | 2 | 3 | 4]:MAXimum

Peak to REF LEVEL

Sets the value of the reference level equal to the value of the highest point on the active trace.

Key Path Amplitude > Peak to REF LEVEL

Related Functions Reference Level

Remote Commands CALCulate[1 | 2 | 3 | 4 | 5 | 6]:MARKer[1 | 2 | 3 | 4]:MAXimum
 CALCulate[1 | 2 | 3 | 4 | 5 | 6]:MARKer[1 | 2 | 3 | 4]:SRLevel

Perform Calibration

Performs a power or wavelength calibration after the setup has been specified by the user.

Key Path System > Calibration > Power Cal Setup > Perform Calibration

Remote Commands CALibration:WAVelength:INTernal

Pit Excursion (Marker Setup Panel)

Sets the pit excursion value for the marker search routines.

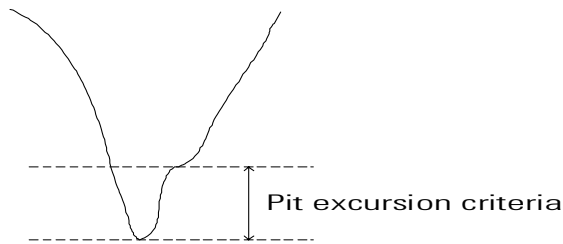

The pit excursion value is used to determine whether or not a local minimum in the trace is to be considered a pit.

For marker search functions, a signal pit is defined as having a fall and then a rise in the displayed response of at least the pit excursion value. Reducing the pit excursion to values less than 3 dB may cause the marker-pitting functions to identify noise spikes as pits. To reduce the noise floor variance to a value less than the pit excursion rate, try changing the reference level at the top of the graticule and increasing sensitivity.

Key Path	Markers > Marker Setup > Pit Excursion
Related Functions	Marker Search Threshold
Remote Commands	CALCulate[1 2 3 4 5 6]:MARKer[1 2 3 4]:PEXCursion:PIT

Pit Search

Places a marker on the lowest amplitude trace point which meets the pit excursion criteria. If no marker is on, Marker #1 will be used for the pit search.

Key Path	Markers > More Marker Functions > Marker Search Menu > Search Mode Pit > Pit Search
Remote Commands	CALCulate[1 2 3 4 5 6]:MARKer[1 2 3 4]:MINimum

Power Calibration Setup

Accesses the setup panel to set the calibration power and calibration wavelength.

Set Calibration Power is the exact amplitude of the calibration source that will be used for the next power calibration. The power entered must be within +10 dB and –3 dB of the amplitude measured using the factory calibration.

Set Calibration Wavelength is the approximate wavelength of the calibration source that will be used for the next user power calibration. The wavelength entered must be within 2.5 nm of the wavelength measured using the factory calibration.

Power Calibration External Path enables power calibration for the external fiber path (path 2). Calibration for Path 1 is always enabled. A 9 μm patchcord must be connected between the Monochromator Output and the Photodetector Input before performing a power calibration on the external path.

Key Path System > Calibration > Power Cal Setup

Remote Commands CALibration:POWer
 CALibration:WAVelength

Power Display

For 86146B only

In Power Meter mode, turns power display on or off.

Key Path Appl's > Measurement Modes > Power Meter Mode > Power Display

Remote Commands DISPlay[:WINDow[1]]:POPup[1 | 2 | 3 | 4][:ALL] OFF | ON | 0 | 1

Power Meter Mode

For 86146B only

Power meter operation is an operation mode available on the 86146B instruments. Power meter mode displays the broadband power of the input light over time. The input light is directly connected to the instrument's photodetector. This bypasses the internal monochromator and prevents any filtering by the resolution bandwidth filters. With power meter mode, you can perform the following:

- measure total power of broadband light sources
- monitor power as a function of time

Monitoring power enables you to observe both long and short term drift and to perform real-time adjustments. Power meter mode places the instrument in the following settings:

Mode	Setting
Sweep time	10 s
Amplitude units	logarithmic
Amplitude scale	5 db/division
Video bandwidth	100 Hz

The input light is connected to the front panel Photodetector Input connector for measurement. The front panel Monochromator Input and Monochromator Output connectors are not used in power meter mode.

Key Path Appl's > Measurement Modes > Power Meter Mode

Remote Commands INSTRument:SElect?
 INSTRument:NSElect

Power Meter Zero

For Agilent 86146B only

Zero's the power meter detector to provide more accurate measurements.

Key Path Appl's > Measurement Modes > Power Meter Mode > Power Meter Zero

Related Functions	Power display Power meter mode
Remote Commands	CALibration:ZERO[:AUTO] ONCE

Power Meter Units

For Agilent 86146B only

Displays the power meter units automatically in watts or in dBm.

Key Path	Appl's > Measurement Modes > Power Meter Mode > Pwr Mtr Units
Remote Commands	CALibration:POWer:VALue <param>

Power On State IP/Last

Selects the state, IP or Last, of the instrument when it is turned on. The default state is IP.

If IP is selected, the instrument will turn on in a known, preset state. With the settings as they would be after pressing the front-panel Preset key. For a list of parameter settings, Refer to "Preset" on page 3-59.

If Last state is selected, the instrument will turn on with the settings as they were when the instrument was turned off. This is equivalent to recalling a saved instrument state or measurement file.

Key Path

System > More System Functions > Service Menu > Power On State IP/Last

Preset

Resets the instrument to a known preset state. Selecting preset aborts any current operations and clears the GPIB output queue. Preset leaves some settings in place, for example, the title on the display.

Table 3-7. Default values

Function	Preset Value	Function	Preset Value
Start wavelength	600 nm	Stop wavelength	1700 nm
Wavelength offset	0	Wavelength step size	Auto
Resolution bandwidth	Auto	Resolution bandwidth to span ratio	0.01
Wavelength units	nm	Medium	Vacuum
Wavelength limit	On	Grating order	Auto
Power reference level	0 dBm	Power reference level position	9
Power scale	10 dB/div	Ratio reference level	0 dB
Ratio reference level position	5	Ratio scale	10 dB/div
Amplitude units	Auto	Ratio units ^a	Auto
Amplitude correction	Off	Source mode	Off
Sensitivity	Auto	Video bandwidth	Auto
Auto range	On	Trans-Z lock	Off
Repetitive sweep	On	Sweep time	Auto
Auto chop	Off	Gated sweep	Off
Trigger mode	Normal	ADC trigger delay	10 μ s
ADC sync out	Off	Sweep limit	Off
Trace length	1001	Current source pulse width	100 μ s
Current source duty cycle	100%	Auto zero	On
User wavelength calibration	Enabled	User power calibration	Enabled
Graticule	On	Annotation	On
Current marker	MKR 1	Normal marker interpolation	Off
Bandwidth marker interpolation	On	Normal marker units	nm
Bandwidth marker units	nm	Peak search threshold	-90 dBm
Threshold enable	Off	Peak search excursion	3 dB
Peak search excursion	3 dB	Peak search on end-of-sweep	Off
Marker search limit	Off	Line markers	Off
Marker noise normalization bandwidth	1 nm	OSNR Mode	auto
		OSNR Offset	0.4 nm
Marker 1-4	Off	Marker 1-4 bandwidth	Off

Function Reference

Print

Function	Preset Value	Function	Preset Value
Marker 1–4 bandwidth amplitude	–3 dB	Marker 1–4 delta	Off
Marker 1–4 noise	Off	Marker 1–4 delta marker units	nm
Current trace	TRA	Trace integration	Off
Trace integration limit	Off	Trace mean	Off
Trace mean limit	Off	Trace average count	100
Trace data format ^a	ASCII	TRA visibility	On
TRB–TRF visibility	Off	TRA update	On
TRB–TRF update	Off	TRA–TRF min hold	Off
TRA–TRF max hold	Off	TRA–TRF averaging	Off
TRA–TRF trace math	Off	TRB–TRF data	3-point dummy trace
Raw trace	3-point dummy trace	Fiber state ^b	Internal

a. Accessible only via the remote interface.

b. For /86146B only.

Key Path	Preset
Related Functions	Factory Preset (IP)
Remote Commands	SYSTem:PRESet

Print

The print function can be accessed by the front panel print key or by using the drop-down File menu print selection. Use this function to print a copy of the display. Print location is determined by the Printer Setup panel. See “File Sharing and Printing over a Network” on page 2-25

Remote Commands	HCOPY:IMMEDIATE
-----------------	-----------------

Printer Setup

Accesses the printer setup panel that allows you to select either the internal printer or external printer as the print destination.

Key Path System > Printer Setup

Remote Commands HCOpy:DESTination

Printer Shares

Uses the LAN (local area network) to print data to network printers. The data can be printed on designated, PCL3 format or newer printers.

To access the printer share softkeys, you must first configure the network refer to "Connecting to the OSA over the Network" on page 4-6 and enter the user share identity/user profile information for remote shares (refer to "File Sharing and Printing over a Network" on page 2-25). The softkeys for file and printer share will then become available for selection.

Note Samba® or Microsoft® software must be installed to run the file share programs.

Note If networking is not configured, the command will generate a "Settings conflict" error.

Key Path System > More System Functions > GPIB & Network Setup > Printer Shares

Recall (Recall Setup Panel)

Selects whether all measurement data or only trace data will be recalled from internal memory or floppy disk or network file shares. See "Recalling Measurement and Trace Data" on page 2-23

When Measurement (All Visible + State) is selected, all instrument conditions will be recalled. When the file is recalled, the instrument state will be set to the same state as when the file was saved.

When Trace(s) Only is selected, the trace data is displayed under the current instrument conditions.

Note To insure accurate measurements, a wavelength calibration should be performed each time measurement is recalled from memory.

Key Path Save/Recall > Recall Menu > Recall

Function Reference
Recall From (Recall Setup Panel)

Remote Commands (Measurement) *RCL
(Trace Only):MMEMory:LOAD:TRACe
(File Share):MMEMory:CATalog?FSHare1FSHare2|FSHare3|FSHare4

Recall From (Recall Setup Panel)

Selects whether the data is recalled from a floppy disk, from internal memory, or from network file share. See "Recalling Measurement and Trace Data" on page 2-23

Key Path Save/Recall > Recall Menu > Recall From

Remote Commands *RCL FLOPpy|INTernal|Network File Share
MMEMory:LOAD:TRACe

Recall Menu

Accesses the Recall Setup panel for the following settings:

- Recall (all measurement data or trace data only)
- Recall From (recall from a floppy disk or from the internal drive)
- Network File Share 1 | 2 | 3 | 4
- Network File Path

Note	To insure accurate measurements, a wavelength calibration should be performed each time measurement data is recalled from memory.
------	---

Key Path	Save/Recall > Recall Menu
----------	---------------------------

Remote Commands	MMEMory:LOAD:TRACe
-----------------	--------------------

Reference Level

Specifies the reference level value, the maximum expected power to be measured, at the reference level position. The reference level position is indicated on the display by a dashed green line and the REF annotation on the display. The default position is one major graticule division from the top of the display. The reference level is entered in dBm. Use the Amplitude Setup panel to change the reference level position. See "Reference Level Position (Amplitude Setup Panel)" on page 3-64

Key Path	Amplitude > Reference Level
----------	-----------------------------

Related Functions	Amplitude Setup (Reference Level Position), Scale/Div
-------------------	---

Remote Commands	DISPlay:WINDow:TRACe:Y:SCALE:RLEVEL
-----------------	-------------------------------------

Reference Level Position (Amplitude Setup Panel)

Determines the position of the reference level on the graticule. Setting this value to zero divisions places the reference level on the very bottom of the grid. Setting the reference level to 10 divisions places the reference level at the top of the grid. The default (or preset) position is 9 divisions, which is one major graticule down from the top of the display. See "Reference Level" on page 3-63

The reference level position can be changed using the knob, step keys, or numeric keypad. When using the knob or step keys, the value will automatically change. When using the numeric keypad, a terminator must be selected from the softkey panel.

Key Path	Amplitude > Amplitude Setup > Reference Level Position
Related Functions	Amplitude Units, Amp Display Mode, Reference Level, Scale/Div
Remote Commands	DISPlay:WINDow:TRACe:Y:SCALe:RLPOS

Remote File Share Panel

Uses the LAN (local area network) to store, recall, or delete data to remote hard drives. The data can then be accessed and shared among the users and printed on designated, network printers. See "Recalling Measurement and Trace Data" on page 2-23

Note	To access the file and printer share softkeys, you must first configure the network and enter the user share identity/user profile information for remote shares. The softkeys for file and printer share will then become available for selection.
------	---

Key Path	System > More System Functions > GPIB & Network Setup > File Shares > Remote File Shares
Related Functions	Remote Printer Share
Remote Commands	MMEMORY:FSHAre [1 2 3 4][:PATH] <param> MMEMORY:FSHAre [1 2 3 4][:ADDRes] <param>

Remote Printer Share Panel

Uses the LAN (local area network) to print to designated, network printers. See “Recalling Measurement and Trace Data” on page 2-23

Note	To access the file and printer share softkeys, you must first configure the network and enter the user share identity/user profile information for remote shares. The softkeys for file and printer share will then become available for selection.
------	---

Key Path	System > More System Functions > GPIB & Network Setup > Printer Shares > Remote File Share
----------	--

Related Functions	Remote File Share
-------------------	-------------------

Remote Commands	HCOPY:DEvice:PSHare[1 2 3 4][:PATH]<param> HCOPY:DEvice:PSHare[1 2 3 4]:ADDRess<param> HCOPY:DESTination"SYSTem:COMMunicate:NETWork[1 2 3 4]
-----------------	--

Repeat Sweep

Sweeps the spectrum continuously and updates the measurement data after each sweep. Repeat Sweep ensures evenly timed sweeps for a stable display of the current tuning range. Sweeps will continuously repeat as long as the instrument is in repeat sweep mode. The SWEEP indicator light on the front panel of the instrument is on when the sweep is in progress. See “Single Sweep” on page 3-79

Key Path	Bandwidth/Sweep > Repeat Sweep
----------	--------------------------------

Related Functions	Single Sweep
-------------------	--------------

Remote Commands	INITiate:CONTInuous
-----------------	---------------------

Res BW

Sets the resolution bandwidth value to be used. This determines the instrument's ability to display two closely spaced signals as two distinct responses.

The resolution bandwidth can be set to one of the following values:

- For 86142B, 86143B, 86145B: 0.06 nm, 0.1 nm, 0.2 nm, 0.3 nm, 0.5 nm, 1 nm, 2 nm, 5 nm, 10 nm.
- For 86146B internal path: 0.06 nm, 0.07 nm, 0.1 nm, 0.14 nm, 0.2 nm, 0.33 nm, 0.5 nm, 1 nm, 2 nm, 5 nm, 10 nm.
- For 86146B external path: 0.04 nm, 0.05 nm, 0.07 nm, 0.1 nm, 0.2 nm, 0.3 nm, 0.5 nm, 1 nm, 2 nm, 5 nm, 10 nm.

In Auto mode, the resolution bandwidth is coupled to the span in a preset 0.01:1 ratio. This means that the instrument attempts to set a bandwidth value that is 1% of the span setting. You can alter this behavior by manually setting the resolution bandwidth.

For the greatest measurement range and signal to noise ratio performance, a resolution bandwidth of 10 nm is recommended. Narrower bandwidths can be used if greater wavelength resolution is required.

Key Path

Bandwidth/Sweep > Res BW

Remote Commands

SENSe:BANDwidth:RESolution:AUTO
SENSe:BANDwidth | BWIDth:RESolution

Reset Min/Max Hold

Resets trace hold data and returns to the Traces function keys where you can select an active trace, trace input, update, view, and hold functions.

Key Path Traces > Hold (trace) > Reset Min/Max Hold

Remote Commands CALCulate[1 | 2 | 3 | 4 | 5 | 6]:MAXimum:CLEar
CALCulate[1 | 2 | 3 | 4 | 5 | 6]:MINimum:CLEar
CALCulate[1 | 2 | 3 | 4 | 5 | 6]:MAXimum:STATe
CALCulate[1 | 2 | 3 | 4 | 5 | 6]:MINimum:STATe

Restore Internal Memory

Accesses the instrument restore utility. This operation will remove all existing files from internal memory (that is, measurement, trace, and specification sets) and replace them with files from a floppy disk. These files are created using the Backup Internal Memory function. See "Backing Up or Restoring the Internal Memory" on page 2-19

Key Path Save/Recall > Backup/Restore Menu > Restore Internal Memory

Revision

Displays the instrument's firmware revision information. See "Help" on page 3-28 and "Firmware Upgrade" on page 3-27.

Key Path System > Help > Revision

Remote Commands *IDN?

Save (Save Setup Panel)

Selects whether all measurement data or only trace data will be saved. See "Saving Measurement and Trace Data" on page 2-19.

Function Reference

Save (Save Setup Panel)

When Measurement (All Visible + State) is selected, all instrument conditions will be saved. The measurement data is saved in binary format (.dat file). This includes the traces and all measurement conditions. The .dat file format can only be read by the instrument. You will not be able to view this file on your PC. When the file is recalled, the instrument state will be set to the same state as when the file was saved.

The Trace(s) Only files are saved in comma separated variable (.csv) format. When the file is recalled, the trace data is displayed under the current instrument conditions.

If you choose to automatically name your file, measurement data is saved to the filename ST_XXXX.dat and Trace(s) only is saved to the filename TR_XXXX.csv. "XXXX" represents a numbering system which is incremented each time the measurement data is saved. For example, the first time you save Trace(s) only data, the filename TR_00001.csv will be assigned. Otherwise, a filename can be specified, refer to "Entering a Filename Using the Arrow Keys" on page 2-21 and to "Entering a Filename using an External Keyboard" on page 2-22.

Key Path

Save/Recall > Save Menu > Save:

Remote Commands

(Measurement) *SAV
(Traces Only):MMEMory:STORe:TRACe

Save Graphics (Save Setup Panel)

Saves graphic data in CGM or GIF format.

The CGM (Computer Graphics Metafile) format is a vector graphics format that describes pictures and graphical elements in geometric terms.

The GIF (Graphics Interchange format) is a cross platform graphic standard. GIF formats are commonly used on many different platforms and readable by many different types of software.

This selection is only valid when saving to the floppy drive.

Key Path Save/Recall > Save Menu > Save Graphics

Remote Commands HCOpy:DEvice:LANGuage GIF | CGM

Save Setup

Accesses the setup panel to configure the save settings:

- file name (create a file name automatically or manually)
- network file path
- network file share
- save (all measurement data or trace data only)
- save graphics (save graphics and the graphic format)
- save to (save to a floppy disk or to the internal drive)
- save traces (select trace(s) to save)

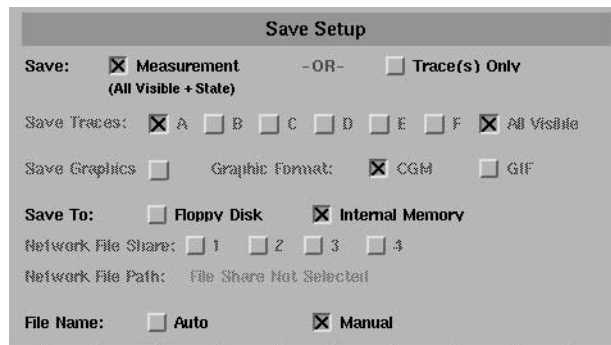

The Save Setup panel

Function Reference

Save Setup

Setup Panel Selections

File Name

Selects manual or automatic mode for choosing a file name.

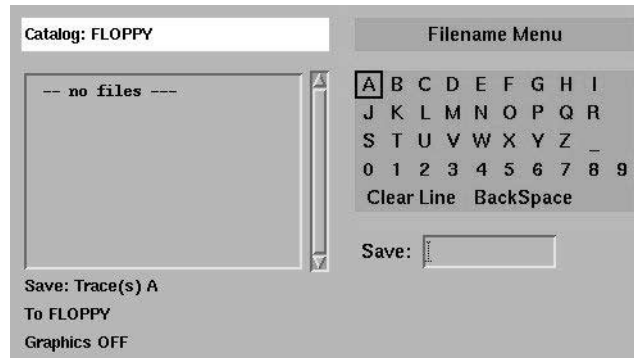

The Filename Menu setup panel

Network File Path

Uses the LAN (local area network) to print to designated, network printers.

Note

To access the file and printer share softkeys, you must first configure the network and enter the user share identity/user profile information for remote shares. The softkeys for file and printer share will then become available for selection.

Network File Share

Uses the LAN (local area network) to store, recall, or delete data to remote hard drives. The data can then be accessed and shared among the users and printed on designated, network printers.

Note

To access the file and printer share softkeys, you must first configure the network and enter the user share identity/user profile information for remote shares. The softkeys for file and printer share will then become available for selection.

Save

Saves the measurement data in a binary format (.dat file). This includes the traces and all measurement conditions. When the file is recalled, the instrument state will be set to the same state as when the file was saved. The Trace(s) Only option creates an ASCII (.csv) file. When the file is recalled, the trace data will be displayed under the current instrument settings.

Save Graphics

Allows you to save graphic data in one of two formats.

CGM (Computer Graphics Metafile format), is a vector graphics format that describes pictures

and graphical elements in geometric terms. The file is saved with a .cgm extension. This selection is valid only when saving to the floppy drive.

GIF (Graphics Interchange format), is a cross-platform graphic standard. GIF formats are commonly used on many different platforms and readable by many different kinds of software. The file is saved with a .gif extension. GIF supports up to 8-bit color (256 colors).

Save to

Selects saving data to a floppy disk or to internal memory.

Save Traces

Selects the traces to be saved.

Key Path	Save/Recall > Save Menu
Remote Commands	(Graphics format) HCOPy:DEVIce:LANGUage (Measurement) *SAV (Trace only) MMEMory:STORe:TRACe (Network File Share)MMEMory:FSHAre [1 2 3 4][:PATH] <param> (Network File Share)MMEMory:FSHAre [1 2 3 4][:ADDRESS] <param> (Network File Path)HCOPy:DEVIce:PSHAre[1 2 3 4][:PATH] <param> (Network File Path)HCOPy:DEVIce:PSHAre[1 2 3 4]:ADDRESS <param> (Network File Path)HCOPy:DESTination"SYSTem:COMMunicate:NETWork[1 2 3 4]

Save/Recall

Accesses function keys to save and recall measurement results. See "Saving, Recalling, and Managing Files" on page 2-18

- backup/restore menu
- delete menu
- fast measure recall
- fast measure save
- format floppy disk
- recall menu
- save menu

Key Path	Save/Recall
----------	-------------

Save To (Save Setup Panel)

Selects saving data to a floppy disk or to internal memory.

Key Path Save/Recall > Save Menu > Save To

Remote Commands *SAV FLOppy | INTernal

Save Traces (Save Setup Panel)

Selects the traces to be saved. Select Save Traces and then select the individual trace(s) or all the current trace data. See "Saving Measurement and Trace Data" on page 2-19

Key Path Save/Recall > Save Menu > Save Traces

Remote Commands MMEMory:STORe:TRACe

Scale/Div

Specifies the dB per division of the vertical (that is, amplitude) scale. If Auto is specified in the Auto Measure Setup panel, the measurement function sets the vertical scale based on the dynamic range of the signal. If a particular vertical scale is desired, use the step keys or key pad to enter the desired dB/div in the dB dialog box. The amplitude scale can be set from 0.01 to 20 dB per division. The Preset value is 10 dB per division.

Key Path Amplitude > Scale/Div

Related Functions Display Mode Log Linear, Reference Level

Remote Commands DISPlay:WINDow:TRACe:Y:SCALE:PDIVision

Search Limit On/Off

When the search limit function is on, all the marker peak/pit searches will apply only to the range specified by the two wavelength line markers.

Key Path Markers > More Marker Functions > Line Marker Menu > Advanced Line Mkr Functions > Search Limit On/Off

Remote Commands CALCulate[1 | 2 | 3 | 4 | 5 | 6]:MARKer[1 | 2 | 3 | 4]:SRANge:STATe

Search Mode Peak/Pit

Allows you to select between peak and pit search modes. The selection on the marker search menu will change depending on which of the two modes is selected.

Key Path Markers > More Marker Functions > Marker Search Menu > Search Mode

Remote Commands CALCulate[1 | 2 | 3 | 4 | 5 | 6]:MARKer[1 | 2 | 3 | 4]:MAXimum
CALCulate[1 | 2 | 3 | 4 | 5 | 6]:MARKer[1 | 2 | 3 | 4]:MINimum

Select Path INT/EXT

For 86146B only.

Allows you to select between internal (50 μm) and external (9 μm) fiber. The dual fiber outputs from the monochromator allow the instrument to have improved resolution bandwidth and dynamic range when using the 9 μm fiber. The 50 μm fiber is the default setting.

Internal (50 μm) path resolution bandwidth include: 0.06, 0.1, 0.14, 0.2, 0.33, 0.5, 1, 2, 5, 10 settings

External (9 μm) path resolution bandwidth include: 0.04, 0.06, 0.1, 0.14, 0.2, 0.33, 0.5, 1, 2, 5, 10 settings

Key Path Bandwidth/Sweep > Select Path

Remote Commands INSTRument:SElect "FILTER"

Sensitivity

Requests the lowest amplitude signal that can be measured relative to the power at "top of screen". It is defined as the signal that is six times the RMS noise. The minimum setting is -100 dB. An error will be reported for values outside of this range and the sensitivity will round to the nearest valid sensitivity. See "Setting the Sensitivity" on page 2-8

Manual allows manual input of sensitivities and enables auto gain ranging. The "top of screen" and the sensitivity setting determines the requested dynamic range. The system will sweep once per gain stage and may require up to three sweeps to achieve the requested dynamic range.

Auto automatically chooses a sensitivity and a single gain range based on "top of screen". This will result in approximately 40 dB of dynamic range.

The sweep time (ST) that is displayed in the lower portion of the display is the time for the OSA to sweep over one gain stage. The OSA may take up to three sweeps in three different gain stages to make the measurement. This depends on the settings for sensitivity, reference level, auto range and also the particular device being measured. The final data trace is a blended composite of each trace taken in the different gain stages. For more information refer to "Setting the Sensitivity" on page 2-8.

An increase in sensitivity may also require a narrower video bandwidth, which will slow the sweep speed. Normally, the optical spectrum analyzer selects the greatest sensitivity possible that does not require amplification changes during the sweep. If you manually increase the sensitivity level, the sweep pauses to allow this change in gain.

The settings for sensitivity, video bandwidth and sweep time interact. If the sensitivity is set to manual, the video bandwidth and sweep time may be forced to Auto mode. If the video bandwidth is set to manual, the sensitivity and sweep time may be forced to Auto. If the sweep speed is set to manual and is set too fast, the over sweep indicator will come on in the display area. Since these settings interact, it is recommended that only one of the settings be changed, whichever setting is most important to the measurement task being performed.

Key Path	Amplitude > Sensitivity
Related Functions	Amplitude Setup (Auto Ranging), Reference Level
Remote Commands	(Automatic) SENSE: POWer:DC:RANGe:LOWer:AUTO (Manual) SENSE: POWer:DC:RANGe:LOWer

Set Time/Date

Accesses the time/date setup panel. The selections are current time (24-hour format), current date, and time zone. To make changes:

- use the navigation keys to select the dialog box
- use the numeric entry keys to change the time and date
- use the step keys to change the time zone and month
- press Set Time/Date when the desired changes are completed

Changing the time, date, or time zone causes the instrument to reboot with the current information.

Key Path	System > More System Functions > Set Time/Date
----------	--

Set Title

Accesses the Title Setup panel to add a title to the display. Use the softkeys to change or select the items from the setup panel. Refer to "Adding a Title to the Display" on page 2-18

Key Path	System > Set Title
Remote Commands	DISPlay[:WINDow[1]]:TEXT:DATA

Show Critical Errors

Opens a window displaying critical errors. You can print the queue, clear the queue, or page up and down to view the information. If no errors are generated, the function will be shaded.

Key Path	System > Help > Show Critical Errors
Related Functions	Show Hardware Errors, Show Notices, Show Warnings, or Revision
Remote Commands	SYSTEM:ERRor?

Show HW Errors

Opens a window displaying hardware errors. You can print the queue, clear the queue, or page up and down to view the information. If no errors are generated, the function will be shaded.

Key Path	System > Help > Show HW Errors
Related Functions	Show Critical Errors, Show Notices, Show Warnings, or Revision
Remote Commands	SYSTem:ERRor?

Show Notices

Opens a window displaying notices. You can print the queue, clear the queue, or page up and down to view the information. If no notices are generated, the function will be shaded.

Key Path	System > Help > Show Notices
Related Functions	Show Hardware Errors, Show Critical Errors, Show Warnings, or Revision
Remote Commands	SYSTem:ERRor?

Show Warnings

Opens a window displaying warnings. You can print the queue, clear the queue, or page up and down to view the information. If no warnings are generated, the function will be shaded.

Key Path	System > Help > Show Warnings
Related Functions	Show Hardware Errors, Show Critical Errors, Show Notices, or Revision
Remote Commands	SYSTem:ERRor?

Single Mode Alignment

For 86141B only

Performs an auto align on the external signal path. The external path from the monochromator output to the photo diode input must be connected before performing the auto align.

When Single Mode Alignment is selected, follow the on-screen instructions in the setup panel.

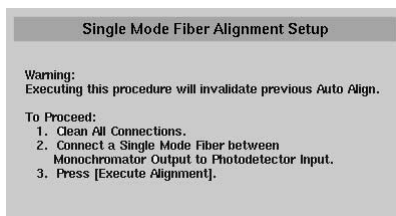

The Single Mode Fiber Alignment Setup panel

Key Path	Appl's > Measurement Modes > Filter Mode > Single Mode Align
Related Functions	CALibration:ALIGNment
Remote Commands	INSTRument:SElect

Single Sweep

Initiates one sweep of the measurement range. Use this function to update the displayed measurement data. Refer to "Repeat Sweep" on page 3-65

Trigger conditions must be met in order for a single sweep to occur. The SWEEP indicator light on the front panel is on when the sweep is in progress. The indicator is off when the sweep is complete.

Tip: Single sweep mode is especially useful when programming the instrument and under the following circumstances:

- insuring the trace reflects current measurement range settings
- capturing traces before processing them with math commands
- capturing traces before positioning markers

Key Path Bandwidth/Sweep > Single Sweep

Related Functions Repeat Sweep

Remote Commands INITiate:IMMEDIATE

Span

Defines the wavelength measurement range for viewing the spectrum.

The span is set symmetrically about the center wavelength. The resolution of the wavelength readout decreases with an increase in the span setting. When the span is set to 0, the display's horizontal axis represents time instead of wavelength. A span of 0 (called zero span mode) configures the instrument as a fixed tuned receiver. Refer to "Using Span to Zoom In" on page 2-7

Note Zero span mode requires that sensitivity be in Auto mode.

The wavelength measurement range can also be set using the Start WL and Stop WL functions.

If you increase the span around a center wavelength beyond one of the end wavelength limits, the center wavelength will change to a value that will allow the span to increase. For example, if the center wavelength is set to 1680 nm and you increase the span to 100 nm, the center wavelength changes to 1650 nm in order to be able to accommodate the 100 nm span.

Key Path Wavelength > Span

Function Reference

Start WL

Related Functions Start WL, Stop WL, Center WL

Remote Commands SENSE:WAVelength:SPAN

Start WL

Sets the start wavelength. The center wavelength and span are adjusted so that:

$$\text{Start} = \text{Center} - (\text{Span}/2)$$

Use the knob, step keys, or numeric keys to enter the desired value.

If the instrument is in zero span, this command sets the center wavelength to the value specified.

The default setting for start wavelength is 600 nm.

Key Path Wavelength > Start WL

Related Functions Span, Stop WL, Center WL

Remote Commands SENSE:WAVelength:START

Stop WL

Specifies the stop wavelength. The center wavelength and span are adjusted so that:

$$\text{Start} = \text{Center} - (\text{Span}/2)$$

Use the knob, step keys, or numeric keys to enter the desired value.

If the instrument is in zero span, this command sets the center wavelength to the value specified.

The default for stop wavelength is 1700 nm.

Key Path Wavelength > Stop WL

Related Functions Span, Start WL, Center WL

Remote Commands SENSE:WAVelength:STOP

Sweep Points

Specifies the number of data points taken for a sweep. The more data points the better the trace resolution, but the longer the sweep time. You can select from 3 to 10001 points. Enter the number of data points using the step keys, numeric key pad, or knob. The default is 1001 points.

Key Path Traces > Trace Setup > Sweep Points

Remote Commands SENSE:SWEep:POINts

Sweep Time

Specifies the amount of time required for the instrument to sweep the current measurement range. The instrument automatically selects sweep times based on coupling of the following instrument settings:

- wavelength span
- resolution bandwidth
- video bandwidth
- sensitivity
- trace length
- power level

Coupling of these parameters yields optimum amplitude accuracy. When Sweep Time is set to Auto, the instrument always uses the fastest sweep possible while still maintaining the specified accuracy. Coupled, sweep times range from 56.3 mn to a maximum value that depends on the number of trace points used to draw the trace. This relationship is shown in the following equation:

$$56,3ms \leq \text{sweep time} \leq (1min)(\text{trace points})$$

The default number of trace points is 1001, so the maximum sweep time is normally 100 seconds. When Sweep Time is in manual mode, the sweep time can be set from 56.3 ms to a maximum of 1000 seconds. If you change the number of trace points, the maximum sweep time changes as well.

Function Reference
Switch Path Auto Align Now

Note	If the sweep time is set too fast, an over sweep message appears indicating the display is no longer calibrated and that trace data may not meet specifications. Increase the sweep time until the over sweep message disappears. If the sweep time is set too slow, measurement times may be excessively long.
Key Path	Bandwidth/Sweep > Sweep Time
Related Functions	wavelength span, resolution bandwidth, video bandwidth, sensitivity, trace length, power level
Remote Commands	SENSe:SWEp:TIME:AUTO SENSe:SWEp:TIME

Switch Path Auto Align Now

For 86146B Filter Mode only.

Switches to the 9 μm filter mode path and performs an Auto Align. To ensure maximum amplitude accuracy, connect the 9 μm fiber between the monochromator output and the photodetector input and then press Switch Path Auto Align Now. This aligns the output of the monochromator with the photodetector input for improved amplitude accuracy. The automatic alignment procedure should be performed whenever the instrument has been:

- moved
- subjected to temperature changes $> 2^\circ\text{C}$
- turned off and warmed up for an hour at the start of each day

The automatic alignment requires the connection of an external light source. This can be a broadband or narrowband source. If there is insufficient signal power, the automatic alignment will not be performed and an error message will be reported.

The auto align function saves and restores the current instrument state. This allows the auto align function to be used in the middle of a measurement routine.

If markers are turned on, the auto align function attempts to do the automatic alignment at the wavelength of the active marker. If the instrument is in zero span, the alignment is performed at the center wavelength.

Note	<p>The auto align now will overwrite any previous align data. To preserve current auto align data, select Switch Path No Auto Align.</p> <p>The data returned by the alignment is stored in both the 9 μm and the 50 μm table. With the data stored on both tables, the centering for the 50 μm path is improved due to the increased resolution bandwidth of the 9 μm path. Once the align is complete or if you select No Auto Align, the instrument will be ready to detect data via the 50 μm path.</p>
Key Path	Appl's > Measurement Modes > Filter Mode > Switch Path Auto Align Now
Related Functions	Switch Path No Auto Align
Remote Commands	ROUTE:PATH:EXTERNAL CALibration:ALIGN:FILTER

Switch Path No Auto Align

For 86146B Filter Mode only.

Selects the 9 μm filter mode path. You should select this function if the instrument has not be moved, subjected to temperature changes $>2^{\circ}\text{C}$, turned off and warmed up for at least an hour at the start of each day or to preserve previous align data.

Key Path	Appl's > Measurement Modes > Filter Mode > Switch Path Auto Align Now
Related Functions	Switch Path Auto Align Now
Remote Commands	ROUTE:PATH:EXTERNAL

System

Accesses menus for changing, displaying, selecting, and viewing the instrument's functions.

Some of the functions available are:

- shows HW and critical errors, warnings and notices
- sets a title to the display
- displays the firmware revision
- sets printer setup
- moves the active function area
- displays the instrument state information
- changes the display setup
- changes the time and dates
- selects the power-on state
- performs a factory preset
- upgrades the firmware
- zeros the instrument
- sets the wavelength limit
- sets the TransZ 2-3 lock
- changes the auto measure defaults
- sets the GPIB address
- sets networking parameters

Take Sweep

For 86146B Filter Mode only.

Initiates a single sweep that updates the display to show the valid waveform data. Refer to "Repeat Sweep" on page 3-65 and to "Single Sweep" on page 3-79.

Key Path	Appl's > Measurement Modes > Filter Mode > Switch Path Auto Align Now > Take Sweep
Related Functions	Single Sweep
Remote Commands	INITiate:IMMEDIATE

Title (Display Setup Panel)

Turns the display title on or off. When the title selection is on, the title will appear on the display's top, center of the graticule, and on printouts. Create a title in the Title Setup panel (System > Set Title). Use the arrows, step keys, or knob to select the letters for the title. See "Adding a Title to the Display" on page 2-18.

Key Path System > More System Functions > Display Setup

Remote Commands DISPlay:WINDow:TEXT:DATA

Trace Averaging

When averaging is on, you can select the number of measurement sweeps to be averaged, using the 10, 20, 50, 100 softkeys. You can also enter averaging values other than those displayed by using the numeric keypad or the knob.

When the number of sweeps taken is less than the count, the following formula is used to calculate the data:

$$\text{AVG} = \text{sum of current sweeps} / \text{number of averages selected}$$

If the number of sweeps is greater than or equal to the count, the following formula is used to calculate the data:

$$\text{New average} = [(\text{count}-1)/\text{count}] \times \text{last average} + \text{new measurement}/\text{count}$$

Key Path Traces > Averaging

Remote Commands CALCulate[1|2|3|4|5|6]:AVERage:COUNT
CALCulate[1|2|3|4|5|6]:AVERage:STATe

Trace C Math Off

Turns off Trace C math processing.

Function Reference

Trace F Math Off

Key Path Traces > Trace Math Off > Default Math Trace C > Trace C Math Off

Remote Commands CALCulate3:MATH:STATe

Trace F Math Off

Turns off Trace F math processing.

Key Path Traces > Trace Math Off > Default Math Trace F > Trace F Math Off

Remote Commands CALCulate6:MATH:STATe
CALCulate6:MATH:EXPRession:DEFine
TRACe:EXCHange

Trace Integ

Calculates total power. Total power is the summation of the power at each trace point, normalized by the ratio of the trace point spacing and the resolution bandwidth. The analyzer can only calculate the total power of single trace. For example, if a total power calculation is being performed on trace A, turning total power calculation for trace B will turn the calculation for trace A off.

Key Path Markers > More Marker Functions > Line Marker Menu > Advanced Line Mkr Functions > Trace Integ

Related Functions Integrate Limit, Sweep Limit, Search Limit

Remote Commands CALCulate:TPOWER:STATe

Trace Math

Accesses the menu that allows you to manipulate and compare traces by adding or subtracting trace-amplitude and display-line data. Trace Math characterizes changes due to environmental stimulus and displays the cumulative effect of multiple devices. When using trace math, the

traces must be obtained using identical wavelength, scale and amplitude values. Any difference in reference level, amplitude units-per-division, or amplitude units invalidates any data resulting from trace math. See "Using Trace Math to Measure Wavelength Drift" on page 2-28

The following functions can be accessed:

- All Math Off
- Default Math Trace C
- Default Math Trace F
- Exchange Menu
- Trace A Offset

Key Path	Traces > Trace Math Off
Remote Commands	CALCulate[1 2 3 4 5 6]:MATH:STATe CALCulate[1 2 3 4 5 6]:MATH:EXPRession:DEFine TRACe:EXCHange

Trace OffSet

Offsets the active trace by the user-specified value.

Key Path	Traces > Trace Math Off > Remote Commands CALCulate[1 2 3 4 5 6]:OFFSet
----------	--

Traces

Accesses the menu that allows you to select and control traces. Some of the functions available are:

- active trace
- averaging
- hold trace
- trace input
- trace math
- trace setup
- update trace
- view trace

Function Reference

TransZ 2-3 Lock

The instrument displays up to six traces: A, B, C, D, E, and F. When the instrument is first turned on, trace A is the active trace.

TransZ 2-3 Lock

Prohibits the instrument from using a transimpedance gain higher than the 10k ohm stage. The default state for transZ 2-3 lock is off.

Key Path Systems> More System Functions > Service Menu > Adv Service Functions > More Adv Service Menu > TransZ 2-3 Lock

Remote Commands [SENSe]:POWer:RANGe:LOCK

Trigger Mode, Internal

Synchronizes the start of the sweep to an internally generated trigger signal. Internal triggering ensures continuously triggered sweeps with the shortest delay between sweeps. See "Triggering a Measurement" on page 2-9

Key Path Bandwidth/Sweep > More BW/Sweep Functions > Trigger Mode

Remote Commands TRIGger[:SEQuence]:SLOPe
TRIGger[:SEQuence]:SOURce

Update A...F On | OFF

When on, the selected trace is updated after each sweep. When off, the trace data is not updated.

Key Path Traces > Update

Related Functions View A...F

Remote Commands	SENSe:SWEEp:POINts TRACe:FEED:CONTRol TRA TRB TRC TRD TRE TRF,ALWays TRACe:FEED:CONTRol TRA TRB TRC TRD TRE TRF,NEVer
-----------------	---

Use Marker Search Threshold On/Off (Marker Setup Panel)

When on, the marker search function ignores peaks below the threshold value. A dotted line is shown on the display at the threshold level.

Key Path	Markers > Marker Setup > Use Marker Search Threshold
Related Functions	Pit Excursion, Peak Excursion, Marker Threshold Value
Remote Commands	CALCulate:THReshold:STATe

User Profile for Remote Shares

Accesses the username, password, and workgroup fields for access to your network. Use the alphanumeric pad to complete the information. After entering the information, the file shares and printer shares softkeys will become available.

Key Path	System > More System Functions > GPIB & Network Setup > User Share Identity > User Profile for Remote Shares
Related Functions	Printer Share
Remote Commands	SYSTem:COMMunicate:NETWork:USERname <param> SYSTem:COMMunicate:NETWork:PASSword <param> SYSTem:COMMunicate:NETWork:WORKgroup <param>

User Share Identity

Opens a panel to fill-in username, password, and domain. Use the alphanumeric pad to complete the information. After entering the information, the file shares and printer shares softkeys will become available.

Function Reference
User Source Multi-Pt Align

Key Path	System > More System Functions > GPIB & Network Setup > User Share Identity
Related Functions	File Share, Printer Share
Remote Commands	SYSTem:COMMunicate:NETWork:USERname <param> SYSTem:COMMunicate:NETWork:PASSword <param> SYSTem:COMMunicate:NETWork:WORKgroup <param>

User Source Multi-Pt Align

Adjusts the mechanical position of the instrument's internal optical components ensuring amplitude accuracy of your measurements. This function is semi-automatic and aligns equally spaced points within the span and builds the current fiber trajectory table. See "Multi-Point Align" on page 3-41

Connect an external broadband source to the input connector of the instrument. Then set the instrument to the desired values:

- start and stop wavelengths (input range 600 nm to 1700 nm)
- span
 - >3 nm for the external path (Agilent 86146B only)
 - >25 nm for the internal path
- reference level (must be greater than -78 dBm in a 10 nm resolution bandwidth at all points to be aligned)

The instrument auto aligns at equally spaced points within the span and builds the fiber trajectory table (maximum of 32 points). To add or adjust a single point in the trajectory table, move the active marker to the specific wavelength location and press Auto Align & Add to Trajectory. The Multi-Pt Auto Align progress window opens indicating the percentage of completion and the approximate time required for the alignment process. To cancel the align, press the instrument preset key. This table is interpolated to create a linear set of corrections.

If Auto Align is executed after User Source Multi-Pt Align, all of the alignment tracking data will be shifted. In this sense, auto align is done on top of this alignment.

Note	Error 5056, Trajectory align cannot find input signal, will occur if a broadband light source is not connected to the front-panel input connector. Error 5057, Invalid settings for trajectory align, will occur if the start and/or stop wavelength settings are invalid. Error 5060, Trajectory align failed, will occur if the align procedure failed.
------	---

Key Path	System > More System Functions > Service Menu > Adv Service Functions > More Adv Ser-
----------	---

	vice Menu > Multi-Point Align > User Source Multi-Pt Align
Related Functions	Auto Align & Add To Trajectory Auto Align Preset Calibrator Multi-Pt Align
Remote Commands	CALibration:ALIGn:EXternal

User Wavelength Cal Date

Shows the date and time of the last successful user-performed wavelength calibration.

Key Path	Wavelength > Wavelength Setup > User Wavelength Cal Date
Related Functions	Wavelength Calibration

Video BW

Specifies the bandwidth of the post-detection video filter. Filtering occurs after the detection of the light. The minimum value for video bandwidth is 0 Hz. The maximum value is the lesser value of either 3 kHz or the bandwidth of the currently selected transimpedance amplifier. In the auto coupled mode, the video bandwidth has an extremely wide range. This allows the optical spectrum analyzer to avoid unnecessary filtering that would reduce the sweep speed more than required. See "Setting Video Bandwidth" on page 2-6

Normally, the video bandwidth is coupled to the requested sensitivity. Manually entering a video bandwidth sets Sensitivity to Auto. The video bandwidth can be manually set from 100 mHz to 3 kHz, or the bandwidth of the currently selected transimpedance amplifier, whichever is less.

The following functions affect video bandwidth:

- changing the sensitivity value
- changing the reference level
- turning auto ranging on or off

Function Reference

View (trace)

The range of video bandwidths available in auto mode is much greater than can be set manually from the front panel. A lower video bandwidth value requires a longer sweep time. Because of the interdependence between the video bandwidth and sensitivity, it is recommended that either the sensitivity or the video bandwidth be changed, whichever is the most important to the measurement task being performed.

Key Path	Bandwidth/Sweep > Video BW
Related Functions	Sensitivity
Remote Commands	[SENSe]:BANDwidth BWIDth:VIDeo:AUTO [SENSe]:BANDwidth BWIDth:VIDeo

View (trace)

Allows trace A, B, C, D, E, or F data to be viewed. Viewed traces are not updated as sweeps occur unless the Update function is on.

Key Path	Traces > View
Related Functions	Active Trace, Update
Remote Commands	DISPlay:WINDow:TRACe TRA TRB TRC TRD TRE TRF,ON

Wavelength

Accesses a menu to set:

- center wavelength
- peak to center
- span
- start wavelength
- stop wavelength
- wavelength setup

Wavelength Cal Info

Displays the date of the last factory calibration, the last user wavelength calibration date, signal source, wavelengths referenced in, and set calibration wavelength.

Key Path	System > Calibration > Wavelength Cal Setup
Related Functions	Wavelength > Calibration
Remote Commands	CALibrate:WAVelength:DATE?

Wavelength Cal Setup

See "Calibrating Wavelength Measurements" on page 2-13. Accesses the following:

- calibration data will be offset or replaced
- factory wavelength calibration date
- set calibration wavelength
- signal source external or calibrator
- user wavelength cal date
- wavelength referenced in air or vacuum

Wavelength Calibration Setup

Factory Wavelength Cal Date: 16 Sep 1998
User Wavelength Cal Date: 01 Jun 2000 08:53 AM

Signal Source: External Calibrator

Wavelengths Referenced In: Air Vacuum

Set Calibration Wavelength: 1527 nm

When calibration completes, user multi-point wavelength calibration data will be: Offset Replaced

The Wavelength Calibration setup panel

Setup Panel Selections	<i>Factory Wavelength Cal Date</i> Shows the date of the last factory-performed wavelength calibration.
------------------------	--

Function Reference
Wavelength Line Mkr 1/2

User Wavelength Cal Date

Shows the date of the last successful user-performed wavelength calibration.

Signal Source

Selects either an external single wavelength signal source or the internal calibrator as the wavelength calibration source.

Wavelength Referenced In (for external calibration source only)

Selects air or vacuum for the calibration. If the internal calibrator is selected, this selection will not be available.

Set Calibration Wavelength (for external calibration source only)

This is the exact wavelength of the calibration source that will be used for the next user wavelength calibration. The wavelength entered must be within 2.5 nm of the wavelength measured using the factory calibration. If the internal calibrator is selected, this selection will not be available.

User Multipoint Wavelength Calibration Data

Selects either Offset or Replaced for the calibration data. Offset will adjust the user multipoint data at all wavelengths to provide the best wavelength accuracy at the calibration source wavelength.

Replaced will disable the multipoint data when used with an external source (select Offset to re-enable).

Replaced will delete multipoint data when used with the internal calibrator.

Key Path System > Calibration > Wavelength Cal Setup

Remote Commands CALibrate:WAVelength:STATe ON
 CALibrate:WAVelength:STATe OFF
 CALibrate:WAVelength:INTernal

Wavelength Line Mkr 1/2

Allows you to set the positions of the line markers. Wavelength Line Mkr 1 is always to the left of Wavelength Line Mkr 2. When either one of the line markers is accessed, the reduced section of the wavelength is highlighted in blue. The line marker can then be set to the desired position using the knob, step keys, or numeric keypad. This limits the measurement range of the sweep limit, search limit, and integrated power.

Key Path	Markers > More Marker Functions > Line Marker Menu > Wavelength Line Mkr 1 2
Remote Commands	(Wavelength Line Marker 1):CALCulate[1 2 3 4 5 6]:MARKer[1 2 3 4] :SRANge:LOWer (Wavelength Line Marker 2):CALCulate[1 2 3 4 5 6]:MARKer[1 2 3 4] :SRANge:UPPer (Sweep Limit):SENSe:WAVelength:SRANge:UPPer

Wavelength Offset

Specifies the wavelength offset. This is an offset between the measured wavelength and the displayed wavelength. You can calibrate the TLS with a wave meter and correct for any offset. Entering a value in the wavelength offset has no affect on the trace.

Key Path	Wavelength > Wavelength Setup > Wavelength Offset
Remote Commands	SENSe:WAVelength:OFFSet

Wavelength Setup

Accesses the Wavelength Setup panel:

- center wavelength step size
- user wavelength calibration date
- wavelength calibration
- wavelength offset
- wavelengths referenced in
- wavelength units

Key Path	Wavelength > Wavelength Setup
Remote Commands	CALibrate:WAVelength:STATe ON CALibrate:WAVelength:STATe OFF SENSe:WAVelength:OFFSet SENSe:WAVelength:CENTer:STEP:INCRement

Wavelength Units

Sets the display wavelength units to nm, μm , or Ang.

Angstrom (Ang) is a unit of measurement of wavelength of light and other radiation equal to one ten-thousandth of a micron or one hundred-millionth of a centimeter.

Key Path Wavelength > Wavelength Setup > Wavelength Units

Zero Now

Causes the auto zero function to run immediately. This allows you to manually zero the instrument when the auto zero function is off.

In Auto Zero mode, the instrument compensates for temperature-related current drift between each sweep. Although this "zeroing" increases amplitude accuracy, it also increases the time between sweeps. If amplitude accuracy is not critical to your measurement, turn off zeroing to improve throughput.

The instrument performs a more complete zeroing when the instrument is first turned on. You can run this more complete routine anytime by pressing the Zero Now softkey.

Key Path System > More System Functions > Service Menu > Adv Service Functions > Zero Now

Remote Commands CALibration:ZERO:AUTO ONCE

4

"Information and Equipment Required for the Configuration Process" on page 4-2

"Setting Up the OSA for Remote Operation" on page 4-4

"Connecting to the OSA over the Network" on page 4-6

"Using the Reflection X Emulator to Run the Remote Front Panel" on page 4-7

"Using the X Win 32 Emulator to Run the Remote Front Panel" on page 4-9

"Using a UNIX Workstation to Run the Remote Front Panel" on page 4-12

"Using the Remote Front Panel" on page 4-14

Remote Front Panel Operation

Remote Front Panel

The Remote Front Panel capability provides a means to allow the front panel of the OSA to be operated remotely from a PC with an X Windowing emulator or a UNIX workstation with X Windows.

With the exception for update time, which is limited by the speed of the underlying network, there should be no visible difference between what would be displayed on the OSA locally and the remote display.

Information and Equipment Required for the Configuration Process

- 1 Before beginning the OSA network configuration process, obtain the following required information from your Information Technology (IT) department.

In the OSA network configuration process, an IP address and the associated hostname need to be assigned to the OSA and added to the DNS utilized by your PC or UNIX workstation. Gateway and Net Mask information will also need to be specified in order for the OSA to communicate with the LAN.

The new Internet Protocol (IP) address is used to uniquely identify the network address of the OSA. An IP address is a set of four decimal numbers, separated by periods, like 192.170.128.210.

The Hostname associated with the IP address of the OSA.

Net Mask (Subnetwork Mask)# is used to let the Internet Protocol separate the network ID from the full IP address and thus determine whether the source and destination IP address are on the same network.

Gateway address is used to communicate with devices on a different physical network. The gateway address is the address of a routing device that connects your OSA's LAN with other LANs. In some cases, this may be the same address as the IP address of the OSA client.

Local Domain Name is used to identify the name of the unique internet address stating the location and company name.

Domain Name System (DNS) Server IP Address is used to uniquely identify the location of a particular server. An IP address is a set of four decimal numbers, separated by periods, like 192.170.130.215.

Worksheet for your IT department

Internet Protocol (IP) address: _____

Host Name associated with the IP address: _____

Net Mask (Subnetwork Mask)#: _____

Gateway address: _____

Domain Name System (DNS): _____

Local Domain Name: _____

Domain Name System (DNS) Server IP Address: _____

The Network Configuration procedure does not require the NIS configuration. Your PC or UNIX workstation will use the DNS to lookup the OSA location by the host name. Any NIS information entered will not be used in configuring the OSA network for Remote Front Panel operation.

- 2 A keyboard and mouse must be attached to the OSA to complete the procedure. Restart the OSA *after* connecting the keyboard and mouse.
- 3 Before using the remote front panel, the OSA must be connected to the local area network (LAN). There must be no Proxies between the OSA and the remote system. Continuous, normal operation of the OSA is dependent on the speed of the underlying network.

Setting Up the OSA for Remote Operation

- 1 From the OSA's front panel, press System > More System Functions > GPIB & Network Setup > Configure Network.
- 2 When the Network Configuration screen is displayed, press Continue.

The OSA will now restart the operating system and load the Network Configure utility.

- 3 From the Network Configure Utility window, press OK.
- 4 When the Network Configure window opens, press Configure.

During the configuration process, you will be prompted to enter each of the networking parameters as described below. If networking is currently configured, you have the option of accepting the current configuration or updating the networking parameters.

Tip: This is where you can verify the current network settings.

Pressing Unconfig will disable the current network configuration, if any.

- 5 The HP-UX Set Systems Parameters panel is displayed. You will use this panel to supply the information needed to configure the OSA on the network. Press Yes to continue.
- 6 The Required Information window will open. You need to obtain the name of your system (hostname) and your Internet Protocol (IP) address information from your local network administrator before proceeding. Press Yes, Continue if you have the necessary information.
- 7 Enter the Hostname for your OSA, then press OK.
- 8 Press Yes to confirm the hostname.
- 9 You will now be prompted to enter the time zone settings for the OSA. It is important that the OSA time and time zone are consistent with the network where it resides.
- 10 Select the Time Zone region in which the OSA resides, then press OK.
- 11 Select the time and date for the OSA time zone and press OK. Press Yes to confirm the correct time zone or press No if the information is not correct.
- 12 A window is displayed showing the current time and date of the time zone selected, press Yes if correct, or No to make corrections.
- 13 In the System Internet Address panel, enter the Internet Address then press OK. Press Yes if the address is correct.
- 14 When prompted to enter additional network parameters, press Yes.
- 15 Enter the Subnetwork Mask and Gateway IP Address then press OK. If the parameters are correct, press Yes.

- 16 Enter the Domain Name System and DNS Server IP Address then press OK. If the parameters are correct, press Yes.
- 17 Press Close when the Register Node with Name Server window opens.
- 18 When prompted for the NIS Domain Name and NIS Server Name, press Cancel. This is not required for this application.
- 19 Press Done when the Network Configure window opens.
- 20 The Networking Configure Utility window will open. Check the entered information. If all the information is correct, press OK or PRESS BACK to return to the network configuration menu. The OSA will restart, taking approximately five minutes.

Connecting to the OSA over the Network

You can remap the OSA front panel over the network using a PC with an X windowing emulator or a UNIX workstation running X Windows. The following X windowing emulators have been tested to ensure correct OSA remote front panel operation.

- Reflection X revision 8.0.2
- X Win 32 revision 5.0
- UNIX with X Windows

Refer below for specific setup instructions.

Before using the remote front panel ensure:

- That the OSA is connected to the local area network (LAN).
- There are no Proxies between the OSA and the remote system.
- That the underlying network must operate fast enough to allow for reasonable operation of the OSA.
- *If using a PC to run the remote front panel operation, an X Windowing emulator is available on the PC.*

With the exception of the power switch and knob, all front panel OSA functionality is available when using the remote front panel. You can access the OSA functionality via the main menu bar and make any data entries using the PC's keyboard.

Using the Reflection X Emulator to Run the Remote Front Panel

Below are the basic steps for setting up the Reflection X emulator to run the OSA remote front panel. Refer to the Reflection X documentation for further information.

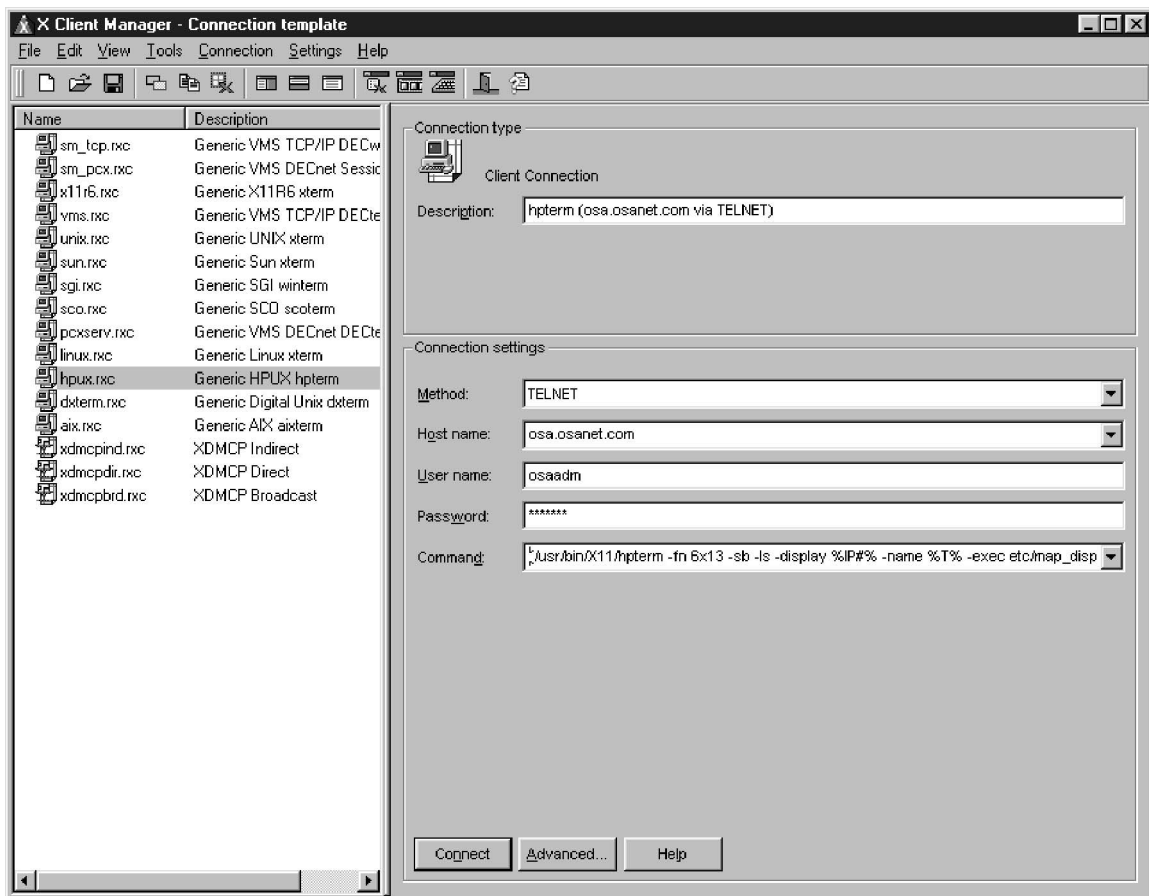

- 1 From the PC Start menu, locate and run the Reflection X emulator.
- 2 From the emulator window, enter the following information:
 - a In the Client Connection area (left side of the window), select hpux.rxc.
 - b In the Method field, select Telnet.

Remote Front Panel Operation

Remote Front Panel

- c In the Host Name field, select the name assigned to the OSA.
 - d In the User Name field, enter osaadm.
 - e In the Password field, enter osaosa1.
 - f In the Command field, you will need to modify the existing command as follows:

```
(usr/bin/x11/hpterm -fn 6x13 -sb -ls -display %IP#% -name %T% -exec etc/map_display &)
```
 - g Click Connect to start the remote front panel controller.
- 3 Continue to "Using the Remote Front Panel" on page 4-14.

Using the X Win 32 Emulator to Run the Remote Front Panel

Below are the basic steps for setting up the X Win 32 emulator to run the OSA remote front panel. Refer to the X Win 32 documentation for further information.

- 1 From the PC Start menu, click X-Win32 > X Win Config.
- 2 From the X-Win32 Configuration window, click Add.

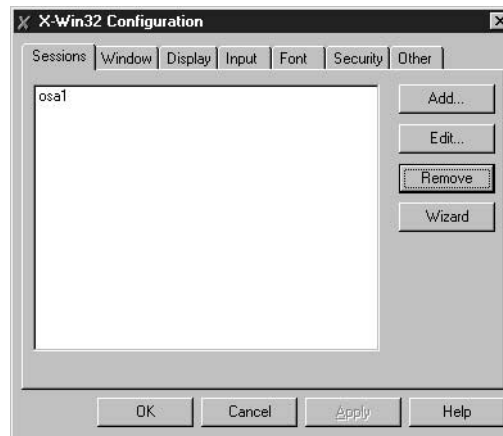

- 3 In the Connect Method window, select rexec and then click Next.

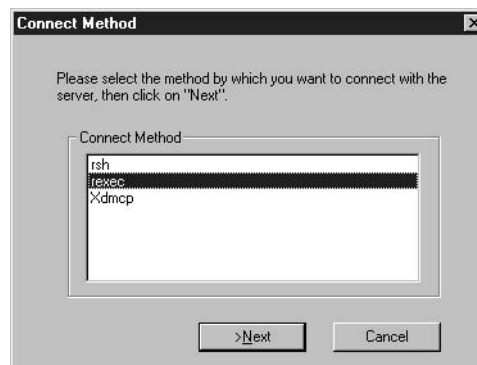

- 4 In the New Session enter the following information:

Remote Front Panel Operation
Remote Front Panel



- a In the Session name field, enter a name to uniquely identify the OSA.

Note

An advantage when using the X Win 32 emulator is that you can run multiple X applications on your desktop in separate windows. For this reason, it is recommended that you name the session after the host system you want to connect to in order to easily identify it when selecting it from a list of sessions.

- b In the Host Name field, enter the host name assigned to the OSA. The host name can either be the name or IP address of the remote host you want to connect to (for example, osa.osanet.com or 247.109.121.43).

- c In the Login name field, enter osaadm.

- d In the Command field, you will need to enter the command as follows:

```
/usr/dt/bin/hpterm -display 141.121.12.345:0.0 -exec etc/map_display
```

where: 141.121.12.345 is the IP address for the PC that you are using now.

Commands are script files executed on the remote host that open X applications on the PC.

- e In the Password field, enter osaosa1.

- f Click Save and then OK to save the newly defined session.

- 5 From the PC, Start menu, click X-Win 32 > X Win 32.

You will notice that an X icon will appear in your windows tray -- usually located in the lower right-hand part of your display.



- 6 Click on the X icon and select the desired OSA session to run the remote front panel operation.
- 7 Continue to "Using the Remote Front Panel" on page 4-14.

Using a UNIX Workstation to Run the Remote Front Panel

In order to access the remote front panel from your UNIX workstation, the X server must be set up to allow connection to the OSA. xhost is the service access control program which allows this access for X Windows.

The xhost program is used to add and delete host names to the list allowed to make connections to the X server. This provides a rudimentary form of privacy control and security.

- 1 From the command prompt type, xhost + hostname. Where hostname is the host name assigned to the OSA.
- 2 From the command prompt type, telnet hostname and then press Enter to telnet to the OSA. Remember that the hostname is the name that is assigned to the OSA.
- 3 When prompted for the login name type, osaadm and then press Enter.
- 4 When prompted for the password type, osaosa1 (or your new password if you have already changed it) and then press Enter.
- 5 At the prompt type, etc/map_display and then press Enter to start the remote front panel controller.
- 6 A Welcome screen is displayed and you are given three command choices,
 - Display accesses a diagnostic tool to show the display parameter setup
 - Enable accesses the remote front panel. This command is used to stop the OSA from operating in normal mode and start operating in the Remote Front Panel mode. The annotation, "Remote Front Panel On" will be displayed on the hardware OSA display.
 - Disable turns the remote front panel off. The remote front panel will close on the PC display and the OSA will restart and return and to normal mode.

A fourth command (which is not displayed) is Passwd.

- Passwd allows you to change the default password to one that is unique for you. It is recommended that you change the default password (osaosa1) at this time. Simply type Passwd at the prompt and enter a new password. The new password must differ from the old password by at least three characters.

Note

Once you changed the password, you will need to remember it for future use. *You will not be able to access the remote front panel capabilities without the new password.*

- 7 From the command prompt, type Enable and then press Enter.
- 8 When prompted, Enter the IP number for the system where the display is, enter the IP address for the UNIX workstation that you are using now and then press Enter.

The remote front panel command will be displayed on the OSA and the OSA will be restarted. You will be able to monitor the restarting process on the PC display. Once the OSA has finished restarting, the front panel will be activated on your PC display.

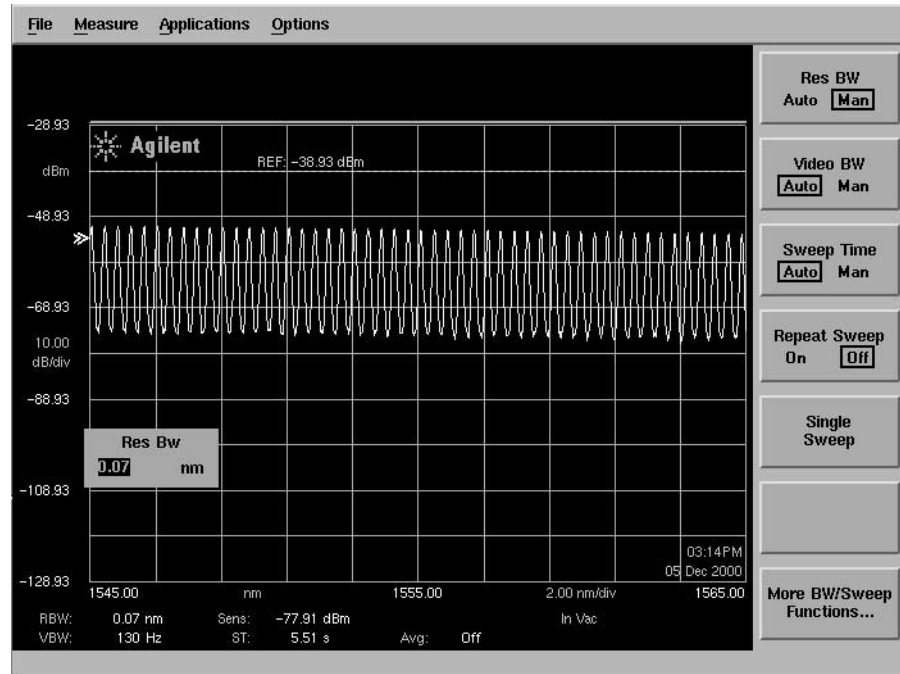

- 9 You can now use the remote front panel just like you would if you were sitting in front of the OSA. Remember to use the main menu bar to access OSA functions and to enter data via the keyboard number keys.
- 10 When you are finished using the remote front panel, in the Map Display window, type Disable. The OSA will reboot into normal mode with the remote front panel turned off. The OSA display will close on the PC.

Using the Remote Front Panel

- 1 In the Map Display window, a Welcome screen is displayed and you are given three command choices,
 - Display accesses a diagnostic tool to show the display parameter setup
 - Enable accesses the remote front panel. This command is used to stop the OSA from operating in normal mode and start operating in the Remote Front Panel mode. The annotation, "Remote Front Panel On" will be displayed on the hardware OSA display.
 - Disable turns the remote front panel off. The remote front panel will close on the PC display and the OSA will restart and return and to normal mode.

A fourth command (which is not displayed) is Passwd.

- Passwd allows you to change the default password to one that is unique for you. It is recommended that you change the default password (osaosa1) at this time. Simply type Passwd at the prompt and enter a new password. The new password must differ from the old password by at least three characters.

Note

Once you changed the password, you will need to remember it for future use. *You will not be able to access the remote front panel capabilities without the new password.*

- 2 From the command prompt, type Enable. The remote front panel command will be displayed on the OSA and the OSA will be restarted. You will be able to monitor the restarting process on the PC display. Once the OSA has finished restarting, the front panel will be activated on your PC display.



- 3 You can now use the remote front panel just like you would if you were sitting in front of the OSA. Remember to use the main menu bar to access OSA functions and to enter data via the keyboard number keys.
- 4 When you are finished using the remote front panel, in the Map Display window, type Disable. The OSA will reboot into normal mode with the remote front panel turned off. The OSA display will close on the PC.

Remote Front Panel Operation
Remote Front Panel

5

Overview	5-2
Error Reporting Behavior	5-4
SCPI-Defined Errors	5-5
OSA Notices	5-16
OSA Warnings	5-17
Application-Specific Warnings	5-29
OSA Status Errors	5-35
OSA Errors	5-36
Firmware Errors	5-38

Status Listings

Overview

This document describes the status listings of the Agilent 8614x series optical spectrum analyzers. Status conditions for the optical spectrum analyzer are grouped into categories.

Error	Indicates the instrument is malfunctioning. Measurement accuracy is probably affected. Errors can be caused by either a hardware or a firmware problem. The instrument requires repair at a Agilent Technologies service center.
Status error	Indicates an internal hardware function is unavailable or not operating within specifications. This is usually a temporary problem, such as a temperature control loop being unsettled. Status errors cannot be cleared by the user. When the condition causing the error is corrected the error will go away.
Warning	A warning is displayed when the optical spectrum analyzer cannot satisfy a request from the user. Parameter entries that are out of range, illegal or unrecognized remote commands or missing hardware options can cause a warning to be displayed. A warning can be displayed if a requested measurement, for example AutoMeasure, cannot be performed due to a missing input signal.
UNCAL	This message alerts the user the requested instrument setup can cause an invalid measurement. For example, manually setting the sweep time to a value that is too fast for other instrument settings.
Notice	A user alert indicating something in the state of the instrument has changed. For example, if the user specifies a particular value for the current duty cycle, a notice will be displayed when the optical spectrum analyzer modifies the pulse width.

The following table lists the error numbers and their definitions.

Number Range	Definition
-1 to -999	Standard SCPI errors
1000 to 2999	OSA notices
3000 to 4999	Application specific notices
5000 to 7999	OSA warnings
8000 to 9999	Application specific warnings
10000 to 11999	OSA status errors
12000 to 13999	Application specific status errors
20000 to 21999	OSA errors
22000 to 23999	Application specific errors
30000 to 32767	Firmware errors

Error Reporting Behavior

Errors are displayed in an on-screen dialog box. To continue operation, the user must acknowledge the error by pressing a button.

Status errors are displayed with a descriptive line in the lower-left corner of the graticule. Immediately press the System key below the display, and then press the *Help* softkey to the right of the display to display more information. A softkey menu is displayed that includes, *Show Critical Errors*, *Show HW Errors*, *Show Warnings*, and *Show Notices*. If there are any errors, warnings or notices, one or more of these keys are enabled. Press the key to display a more complete description of the condition causing the message.

Warnings and notices are displayed in a status line at the bottom of the screen. They are cleared when any front-panel key, other than the System key, is pressed, or they will clear automatically after a few seconds. To view warnings and notices, press the front-panel System key, the *Help* softkey and then the *Show Warnings* or *Show Notices* softkey. UNCAL is displayed as red text in the lower-right corner of the graticule. It is only displayed when a condition exists that can lead to an inaccurate measurement. There are cases when valid measurements can be made while an UNCAL condition exists, but the operator should use caution.

SCPI-Defined Errors

These error messages and descriptions were copied from the *SCPI 1997 Volume 2: Command reference*. The sentences enclosed in brackets “[]” are copied from the error descriptions in the SCPI reference. References are also made to IEEE 488.2 sections for further clarification of events.

Not all the available SCPI error messages were utilized in the optical spectrum analyzer. Only those pertinent to the instrument were implemented.

Note that some of the error messages do not contain descriptions or help messages. These error numbers are reserved for future expansion. This document is subject to further change and development.

Standards related information

Further information on the Standard Commands for Programmable Instruments (SCPI) standard is available from the SCPI consortium.

Contact:

Fred Bode, Executive Director
SCPI Consortium
8380 Hercules Drive, Suite P3
La Mesa, CA 91942
Phone: (619) 697-8790
FAX: (619) 697-5955
CompuServe Number: 76516,254
Fbode@vxinl.com

For more detailed information on the IEEE 488.2 Standard, order a reference copy.

Status Listings
SCPI-Defined Errors

Contact:

The Institute of Electrical and Electronics Engineers, Inc.
345 East 47th Street
New York, New York 10017-2394
Phone: (800) 678-IEEE (US) 8 a.m. – 4:30 p.m. (EST)
(908) 981-1393 (International)
Fax: (908) 981-9667

Standard SCPI errors (–1 to –999)

All positive numbers are instrument-dependent. All negative numbers are reserved by the SCPI standard with certain standard error/event codes described in this document. The value, zero, is also reserved to indicate that no error or event has occurred.

Error/event numbers

The system-defined error/event numbers are chosen on an enumerated (“1 of N”) basis. The SCPI-defined error/event numbers and the <error/event description> portions of the full queue item are listed here. The first error/event described in each class (for example, –100, –200, –300, –400) is a “generic” error. In selecting the proper Error/event number to report, more specific error/event codes are preferred, and the generic error/event is used only if the others are inappropriate.

Command errors

An <error/event number> in the range [–199, –100] indicates that an IEEE 488.2 syntax error has been detected by the instrument’s parser. The occurrence of any error in this class shall cause the command error bit (bit 5) in the event status register (IEEE 488.2, section 11.5.1) to be set.

One of the following events has occurred:

- An IEEE 488.2 syntax error has been detected by the parser. That is, a controller-to-device message was received which is in violation of the IEEE 488.2 standard. Possible violations include a data element which violates the device listening formats or whose type is unacceptable to the device.
- An unrecognized header was received. Unrecognized headers include incorrect device-specific

headers and incorrect or unimplemented IEEE 488.2 common commands.

- A Group Execute Trigger (GET) was entered into the input buffer inside of an IEEE 488.2 <PROGRAM MESSAGE>.

Events that generate command errors shall not generate execution errors, device-specific errors, or query errors; see the other error definitions in this chapter.

Table 5-1. Command Errors (1 of 4)

Error Number	Error Description [description/explanation/examples]
-101	desc = "Invalid character" help = "" [A syntactic element contains a character which is invalid for that type; for example, a header containing an ampersand, SETUP&. This error might be used in place of errors -114, -121, -141, and perhaps some others.]
-102	desc = "Syntax error" help = "" [An unrecognized command or data type was encountered for example, a sting was received when the instrument does not accept strings.]
-103	desc = "Invalid separator" help = "" [The parser was expecting a separator and encountered an illegal character; for example, the semicolon was omitted after a program message unit, *EMC 1:CH1:VOLTS 5.]
-104	desc = "Wrong Parameter Type" help = "" [The parser recognized a data element different than one allowed; for example, numeric or string data was expected but block data was encountered.]
-105	desc = "GET not allowed" help = "" [A Group Execute Trigger was received within a program message (see IEEE 488.2, 7.7).]
-108	desc = "Parameter not allowed" help = "" [More parameters were received than expected for the header; for example, the *EMC common command only accepts one parameter, so receiving *EMC 0,1 is not allowed.]

Status Listings
SCPI-Defined Errors

Table 5-1. Command Errors (2 of 4)

Error Number	Error Description [description/explanation/examples]
-109	desc = "Missing parameter" help = "" [Fewer parameters were received than required for the header; for example, the *EMC common command requires one parameter, so receiving *EMC is not allowed.]
-112	desc = "Program mnemonic too long" help = "" [The header contains more that twelve characters (see IEEE 488.2, 7.6.1.4.1).]
-113	desc = "Undefined header" help = "" [The header is syntactically correct, but it is undefined for this specific device; for example, *XYZ is not defined for any device.]
-120	desc = "Numeric Data Error" help = "" [This error, as well as errors -121 through -129, are generated when parsing a data element which appears to be numeric, including the non-decimal numeric types. This particular error message should be used if the device cannot detect a more specific error.]
-121	desc = "Invalid character in number" help = "" [An invalid character for the data type being parsed was encountered; for example, an alpha in a decimal numeric or a "9" in octal data.]
-123	desc = "Exponent too large" help = "" [The magnitude of the exponent was larger than 32000 (see IEEE 488.2, 7.7.2.4.1).]
-124	desc = "Too many digits" help = "" [The mantissa of a decimal numeric data element contained more than 255 digits excluding leading zeros (see IEEE 488.2, 7.7.2.4.1).]
-128	desc = "Numeric data not allowed" help = "" [A legal numeric data element was received, but the device does not accept one in this position for the header.]

Table 5-1. Command Errors (3 of 4)

Error Number	Error Description [description/explanation/examples]
-131	desc = "Invalid suffix" help = "" The suffix does not follow the syntax described in IEEE 488.2, 7.7.3.2, or the suffix is inappropriate for this device.]
-134	desc = "Suffix too long" help = "" [The suffix contained more than 12 characters (see IEEE 488.2, 7.7.3.4).]
-138	desc = "Suffix not allowed" help = "" [A suffix was encountered after a numeric element which does not allow suffixes.]
-148	desc = "Character data not allowed" help = "" [A legal character data element was encountered where prohibited by the device.]
-150	desc = "String data error" help = "" [This error, as well as errors -151 through -159, are generated when parsing a string data element. This particular error message should be used if the device cannot detect a more specific error.]
-151	desc = "Invalid string data" help = "" A string data element was expected, but was invalid for some reason (see IEEE 488.2, 7.7.5.2); for example, an END message was received before the terminal quote character.]
-158	desc = "String data not allowed" help = "" [A string data element was encountered but was not allowed by the device at this point in parsing.]
-161	desc = "Invalid block data" help = "" [A block data element was expected, but was invalid for some reason (see IEEE 488.2, 7.7.6.2); for example, an END message was received before the length was satisfied.]

Table 5-1. Command Errors (4 of 4)

Error Number	Error Description [description/explanation/examples]
-168	desc = "Block data not allowed" help = "" [A legal block data element was encountered but was not allowed by the device at this point in parsing.]
-170	desc = "Expression error" help = "" [This error, as well as errors -171 through -179, are generated when parsing an expression data element. This particular error message should be used if the device cannot detect a more specific error.]
-171	desc = "Invalid expression" help = "" [The expression data element was invalid (see IEEE 488.2, 7.7.7.2); for example, unmatched parentheses or an illegal character.]
-178	desc = "Expression data not allowed" help = "" [A legal expression data was encountered but was not allowed by the device at this point in parsing.]
-181	desc = "Invalid outside macro definition" help = "" [Indicates that a macro parameter placeholder (\$<number>) was encountered outside of a macro definition.]
-183	desc = "Invalid inside macro definition" help = "" Indicates that the program message unit sequence, sent with a *DDT or *DMC command, is syntactically invalid (see IEEE 488.2, 10.7.6.3).]

Execution errors

An <error/event number> in the range [-299, -200] indicates that an error has been detected by the instrument's execution control block. The occurrence of any error in this class shall cause the execution error bit (bit 4) in the event status register (IEEE 488.2, section 11.5.1) to be set.

One of the following events has occurred:

- A <PROGRAM DATA> element following a header was evaluated by the device as outside of its

legal input range or is otherwise inconsistent with the device's capabilities.

- A valid program message could not be properly executed due to some device condition.

Execution errors shall be reported by the device after rounding and expression evaluation operations have taken place. Rounding a numeric data element, for example, shall not be reported as an execution error. Events that generate execution errors shall not generate Command Errors, device-specific errors, or Query Errors; see the other error definitions in this section.

Table 5-2. Execution Errors (1 of 3)

Error Number	Error Description [description/explanation/examples]
-200	<p>desc = "Execution error" help = "" [This is the generic syntax error for devices that cannot detect more specific errors. This code indicates only that an Execution Error as defined in IEEE 488.2, 11.5.1.1.5 has occurred.]</p>
-213	<p>desc = "INIT:IMM command ignored" help = "An initiate immediate remote command was received. The instrument was in continuous sweep mode when the command was received. The remote command is ignored unless the instrument is in single sweep mode. To select single sweep mode use the INIT:CONT OFF command."</p>
-221	<p>desc = "Settings Conflict Error" help = "A request was made but the instrument settings resulting from the request are in conflict with each other." [Indicates that a legal program data element was parsed but could not be executed due to the current device state (see IEEE 488.2, 6.4.5.3 and 11.5.1.1.5.)]</p>
-222	<p>desc = "Data out of range" help = "A numeric value was entered which is outside the legal range of values for the parameter. The name of the parameter is listed at the end of the error message." [Indicates that a legal program data element was parsed but could not be executed because the interpreted value was outside the legal range as defined by the device (see IEEE 488.2, 11.5.1.1.5.)]</p>

Status Listings
SCPI-Defined Errors

Table 5-2. Execution Errors (2 of 3)

Error Number	Error Description [description/explanation/examples]
-222	desc = "Span out of range" help = "A numeric value was entered which is outside the legal range of values for the span setting. This occurs if the value is too large less than zero or between zero and 0.2nm. Zero span may not be entered by using the DOWN arrow key from 0.2nm; a numeric value of zero must be entered instead." [Indicates that a legal program data element was parsed but could not be executed because the interpreted value was outside the legal range as defined by the device (see IEEE 488.2, 11.5.1.1.5.)]
-223	desc = "Too much data" help = "" [Indicates that a legal program data element of block, expression, or string type was received that contained more data than the device could handle due to memory or related device-specific requirements.]
-224	desc = "Illegal parameter value" help = "" [Used where exact value, from a list of possibles, was expected.]
-257	desc = "File name error" help = "" [Indicates that a legal program command or query could not be executed because the file name on the device media was in error; for example, an attempt was made to copy to a duplicate file name. The definition of what constitutes a file name error is device-specific.]
-272	desc = "Macro Exec Error" help = "" [Indicates that a syntactically legal macro program data sequence could not be executed due to some error in the macro definition (see IEEE 488.2, 10.7.6.3.)]
-273	desc = "Illegal macro label" help = "" [Indicates that the macro label defined in the *DMC command was a legal string syntax, but could not be accepted by the device (see IEEE 488.2, 10.7.3 and 10.7.6.2); for example, the label was too long, the same as a common command header, or contained invalid header
-276	desc = "Macro recursion error" help = "" [Indicates that a syntactically legal macro program data sequence could not be executed because the device found it to be recursive (see IEEE 488.2, 10.7.6.6).]

Table 5-2. Execution Errors (3 of 3)

Error Number	Error Description [description/explanation/examples]
-277	desc = "Macro redefinition not allowed" help = "" [Indicates that a syntactically legal macro label in the *DMC command could not be executed because the macro label was already defined (see IEEE 488.2, 10.7.6.4).]
-278	desc = "Macro header not found" help = "" [Indicates that a syntactically legal macro label in the *GMC? query could not be executed because the header was not previously defined.]

Device-specific errors

An <error/event number> in the range [-399, -300] or [1, 32767] indicates the instrument has detected an error which is not a command error, a query error, or an execution error; some device operations did not properly complete, possibly due to an abnormal hardware or firmware condition. These codes are also used for self-test response errors. The occurrence of any error in this class should cause the device-specific error bit (bit 3) in the event status register (IEEE 488.2, section 11.5.1) to be set. The meaning of positive error codes is device-dependent and may be enumerated or bit mapped; the <error message> string for positive error codes is not defined by SCPI and available to the device designer. Note that the string is not optional; if the designer does not wish to implement a string for a particular error, the null string should be sent (for example, 42, ""). The occurrence of any error in this class should cause the device-specific error bit (bit 3) in the event status register (IEEE 488.2, section 11.5.1) to be set. Events that generate device-specific errors shall not generate command errors, execution errors, or query errors; see the other error definitions in this section.

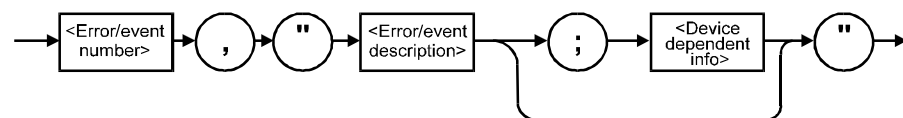

Table 5-3. Device-Specific Errors

Error Number	Error Description [description/explanation/examples]
-310	desc = "System error" help = "" [Indicates that some error, termed "system error" by the device, has occurred. This code is device-dependent.]
-321	desc = "Out of memory" help = "" [An internal operation needed more memory than was available.]

Query errors

An <error/event number> in the range [-499, -400] indicates that the output queue control of the instrument has detected a problem with the message exchange protocol described in IEEE 488.2, chapter 6. The occurrence of any error in this class shall cause the query error bit (bit 2) in the event status register (IEEE 488.2, section 11.5.1) to be set. These errors correspond to message exchange protocol errors described in IEEE 488.2, section 6.5.

One of the following is true:

- An attempt is being made to read data from the output queue when no output is either present or pending.
- Data in the output queue has been lost.

Events that generate query errors will not generate command errors, execution errors, or device-specific errors; see the other error definitions in this section.

Table 5-4. Query Errors (1 of 2)

Error Number	Error Description [description/explanation/examples]
-400	Query error [This is the generic query error for devices that cannot detect more specific errors. This code indicates only that a Query Error as defined in IEEE 488.2, 11.5.1.1.7 and 6.3 has occurred.]

Table 5-4. Query Errors (2 of 2)

Error Number	Error Description [description/explanation/examples]
--------------	--

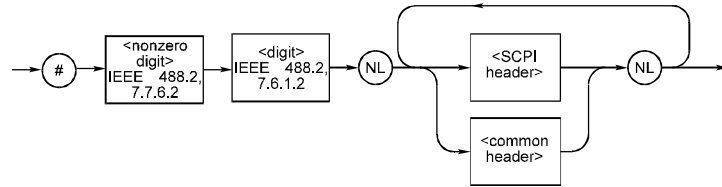

-410 Query INTERRUPTED
 [Indicates that a condition causing an INTERRUPTED Query error occurred (see IEEE 488.2, 6.3.2.3); for example, a query followed by DAB or GET before a response was completely sent.]

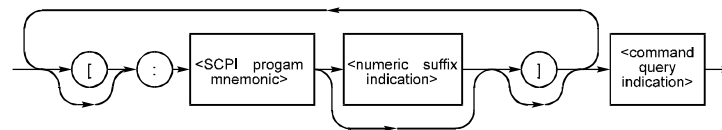

-420 Query UNTERMINATED
 [Indicates that a condition causing an UNTERMINATED Query error occurred (see IEEE 488.2, 6.3.2.2); for example, the device was addressed to talk and an incomplete program message was received.]

-430 Query DEADLOCKED
 [Indicates that a condition causing a DEADLOCKED Query error occurred (see IEEE 488.2, 6.3.1.7); for example, both input buffer and output buffer are full and the device cannot continue.]

-440 Query UNTERMINATED after indefinite response
 [Indicates that a query was received in the same program message after an query requesting an indefinite response was executed (see IEEE 488.2, 6.5.7.5).]

OSA Notices

System control-related error messages or warnings

The OSA system changed a setting and generated a warning that the operation was performed.

Table 5-5. System Control Errors or Warnings

Error Number	Error Description [description/explanation/examples]
1000	desc = "Sensitivity forced to Auto" help = "Sensitivity has been forced to the Auto setting because another instrument setting was made which does not permit sensitivity to be in the Manual setting."
1001	desc = "Old Mezzanine board in system" help = "This OSA has an old mezzanine board installed. It is not necessary to upgrade the mezzanine board but the software will not be able to correctly determine which light source options are available."
1002	desc = "No Delta Marker Amplitude for" help = "The delta marker amplitude display has been turned off due to a units mismatch. The amplitude units of the reference marker are different than those of the delta marker. Values in differing units cannot be compared."
1003	desc = "Trace length increased" help = "Trace length has been increased because the wavelength limit function was turned off. The minimum trace length is larger when the wavelength limit function is off and trace length was below the new minimum value."
2999	desc = "The Notices list has overflowed" help = "The Notices list has overflowed. The last entries received have been deleted."

OSA Warnings

Table 5-6. OSA Warnings (1 of 12)

Error Number	Error Description [description/explanation/examples]
5000	<p>desc = "AutoMeasure cannot find an input signal"</p> <p>help = "The auto-measure procedure cannot find a usable input signal. Make sure you have a signal connected to the optical input. Auto-measure will not work with very small input signals. They must be measured manually."</p>
5001	<p>desc = "AutoAlign cannot find an input signal"</p> <p>help = "The auto-align procedure cannot find a usable input signal. Make sure you have a signal connected to the optical input."</p>
5002	<p>desc = "Cal aborted: there is no active marker"</p> <p>help = "A wavelength calibration using the wavelength of the active marker was requested. The calibration cannot be made because all markers are turned off. Place a marker on the calibration signal and try again."</p>
5003	<p>desc = "Cal aborted: trace resolution is inadequate"</p> <p>help = "A wavelength calibration using the wavelength of the active marker was requested. The calibration cannot be done because the resolution of the marker's trace is inadequate. Trace resolution is defined as wavelength span divided by (trace points - 1) and must be less than 10pm. This problem can be corrected by one or more of the following steps:</p> <ol style="list-style-type: none"> 1. Reduce wavelength span 2. Increase number of trace points"
5004	<p>desc = "Cal aborted: wavelength correction too large"</p> <p>help = "A wavelength calibration was requested. The calibration was aborted since the correction needed is larger than 2nm. Make sure you have the correct index of refraction set. If the wavelength error is still this large the OSA may need to be serviced. The wavelength calibration function is not intended to apply large arbitrary offsets. Use the wavelength offset function for this purpose."</p>

Status Listings
OSA Warnings

Table 5-6. OSA Warnings (2 of 12)

Error Number	Error Description [description/explanation/examples]
5005	desc = "Cal aborted: amplitude correction too large" help = "An amplitude calibration was requested. The calibration was aborted since the correction needed is more than +3dB or less than -10dB. Make sure you have done an Auto-Align prior to calibration. If the amplitude error is still this large the OSA may need to be serviced. The amplitude calibration function is not intended to apply large arbitrary offsets. Use the amplitude offset function for this purpose."
5006	desc = "Cal aborted: cannot find an input signal" help = "The calibration procedure cannot find an input signal close enough to the wavelength and/or amplitude specified. Make sure the wavelength and/or amplitude specified for calibration are correct and verify that an input signal of the correct wavelength and/or amplitude is connected to the optical input."
5007	desc = "Calibration aborted: signal disappeared" help = "The calibration procedure found a signal which subsequently disappeared. Make sure the calibration signal is connected to the optical input and try again."
5008	desc = "Calibration was not successful" help = "The requested calibration procedure did not complete successfully. Verify the instrument setup and the presence of a valid calibration signal. This problem can sometimes be caused by removing or changing the amplitude of the calibration signal during the calibration procedure. In rare cases this error can occur after the OSA has received a severe mechanical shock. Try running AutoAlign"
5009	desc = "I/O error" help = "An error occurred while processing an input/output request"
5010	desc = "The floppy disk is full" help = "There is not enough free space left on the floppy disk to contain the new file(s). Either make room on the existing floppy by deleting unwanted files or try a different floppy disk."
5011	desc = "There is no disk in the floppy disk drive" help = "An operation was requested which uses the floppy disk. There is no disk detected in the floppy disk drive. If there is a disk in the drive it may be of a format which cannot be read. This problem can be fixed by inserting a disk in the floppy disk drive or replacing the current disk with one which is properly formatted."
5012	desc = "The floppy disk is not formatted" help = "An operation was requested which uses the floppy disk. The disk currently in the drive does not appear to be formatted. Use the format utility to format the disk or replace it with a formatted disk."

Table 5-6. OSA Warnings (3 of 12)

Error Number	Error Description [description/explanation/examples]
5013	<p>desc = "The floppy disk is write protected"</p> <p>help = "An operation was requested which writes to the floppy disk. The disk currently in the drive is write-protected. Turn off write protection on the current floppy disk or replace it with another disk."</p>
5014	<p>desc = "The internal memory is full"</p> <p>help = "An operation was requested which uses internal memory. There is not enough free space left in internal memory for this operation. You must make room by deleting one or more files."</p>
5015	<p>desc = "Up/down keys will not alter the span when it is zero"</p> <p>help = "The up/down step keys may not be used to alter the span setting when it is zero. A non-zero numeric value must be entered for span in order to leave zero span mode."</p>
5016	<p>desc = "Incompatible measurement file"</p> <p>help = "An attempt was made to recall a measurement file which is incompatible with the current version of software."</p>
5017	<p>desc = "The requested file does not exist"</p> <p>help = "An attempt was made to access a file which does not exist. Check the spelling of the file name against the listing of available files."</p>
5020–5030	<p>desc = "I/O Error"</p> <p>help "An unexpected error occurred during the I/O operation. Please try the operation again. If the operation involves the floppy disk drive, try a different floppy disk. If the error persists, please make a note of the error number and contact the nearest Agilent Technologies Instrument support center for assistance. In the U.S., call (800) 403-0801. See the <i>Agilent 86140B Series Users Guide</i> for a listing of the Agilent sales and service offices.</p>
5031	<p>desc = "Could not initialize floppy"</p> <p>help => "A request was made to initialize a floppy disk. The operation did not succeed. Check to see that there is a floppy disk inserted in the drive and that the disk is not write protected. This can also be caused by a defective floppy disk."</p>
5032–5043	<p>desc = "I/O Error"</p> <p>help "An unexpected error occurred during the I/O operation. Please try the operation again. If the operation involves the floppy disk drive, try a different floppy disk. If the error persists, please make a note of the error number and contact the nearest Agilent Technologies Instrument support center for assistance. In the U.S., call (800) 403-0801. See the <i>Agilent 86140B Series Users Guide</i> for a listing of the Agilent sales and service offices.</p>

Status Listings
OSA Warnings

Table 5-6. OSA Warnings (4 of 12)

Error Number	Error Description [description/explanation/examples]
5044	<p>desc = "Please cycle power to synchronize system time"</p> <p>help = "The system time clock has been set backwards. Due to internal system requirements it is necessary to cycle power before continuing. Please turn power off and back on again. This must be done to ensure proper system operation."</p>
5045	<p>desc = "Sweep limit markers too close together"</p> <p>help = "The sweep limit function is on and the line markers are too close together. The OSA cannot limit the sweep range to such a small value. The current sweep may be using a wider range than requested. Move the line markers farther apart or turn off sweep limit to resolve this problem."</p>
5046	<p>desc = "AutoAlign cannot find input signal at marker"</p> <p>help = "The auto-align procedure could not find a usable input signal. If there is an active marker auto-align will attempt to align at the marker wavelength without searching for a signal peak. This error can also occur if the input signal amplitude is very low or if the OSA has received a large mechanical shock or if the input signal is removed after the auto-align procedure has begun. Be sure a signal is connected to the optical input. If there is an active marker make sure it is placed on the input signal or turn off all markers."</p>
5047	<p>desc = "Signal disappeared during AutoAlign"</p> <p>help = "The auto-align procedure did not complete. The input signal disappeared during the auto-align procedure. Make sure the input signal is connected to the optical input and try again."</p>
5048	<p>desc = "Wrong trace X axis units for peak to center"</p> <p>help = "The peak-to-center function was requested. This function will only execute if the active trace X axis has units of meters (um nm pm). Change the active trace to one with an X axis in meters or re-measure the active trace in a non-zero span."</p>
5049	<p>desc = "Wrong marker X axis units for active trace"</p> <p>help = "The active marker cannot be placed on the active trace because the desired X axis units do not match the X axis units of the active trace. This is normally caused by recalling a wavelength trace in zero span or a zero span trace in a wavelength span. It can also be caused by loading a trace with conflicting units by remote control."</p>
5050	<p>desc = "Trace not displayed: wrong X axis units"</p> <p>help = "View has been turned on for this trace but it cannot be displayed. The X axis units in the trace do not match the X axis units being displayed. This is normally caused by trying to view a wavelength trace in zero span or a zero span trace in a wavelength span. It can also be caused by loading a trace with conflicting units by remote control."</p>

Table 5-6. OSA Warnings (5 of 12)

Error Number	Error Description [description/explanation/examples]
5051	<p>desc = "AutoMeasure cannot find input signal at marker"</p> <p>help = "The auto-measure function was requested. The auto-measure at marker option was enabled but the active marker was not placed on a valid signal. A valid signal was found but the active marker is too far from that signal. To correct this problem place the marker on the desired signal turn off all markers or disable the auto-measure at marker function."</p>
5052	<p>desc = "Sweep time auto is not allowed in zero span"</p> <p>help = "The sweep time function was requested to switch from manual to auto while in zero span. Automatic sweep time coupling cannot be done in zero span. The desired sweep time must be set explicitly."</p>
5053	<p>desc = "Noise marker not allowed."</p> <p>help = "A request was made to enable the noise marker readout. The readout cannot be enabled for one of the following reasons. Noise markers cannot be used on traces which have X axis units other than meters. This typically occurs in zero span where the X axis units are seconds. Noise markers cannot be used on traces which have Y axis units other than power. This typically happens when trace math is on and the trace Y axis represents a ratio."</p>
5054	<p>desc = "Bandwidth markers are not allowed in zero span"</p> <p>help = "A request was made to enable the bandwidth marker readout while the OSA was in zero span. Bandwidth markers are not permitted when span is set to zero. If a bandwidth marker readout is required set span to a value greater than zero."</p>
5055	<p>desc = "Firmware Upgrade was not successful"</p> <p>help => "A firmware upgrade operation was requested. The firmware upgrade operation cannot be done at this time due to an internal software problem. " + <- .serviceCenterHelp</p>
5056	<p>desc = "Trajectory align cannot find input signal"</p> <p>help = "The trajectory align procedure cannot find a usable input signal. Make sure you have a signal connected to the optical input."</p>
5057	<p>desc = "Invalid settings for trajectory align"</p> <p>help = "The external trajectory align function was requested. It cannot be executed because the start and/or stop wavelength settings are invalid. Start and stop wavelengths must be between 600nm and 1700nm. In addition the difference between start and stop wavelengths (span) must be greater than 25nm. To correct this problem adjust the start and/or stop wavelength settings to be valid."</p>

Status Listings
OSA Warnings

Table 5-6. OSA Warnings (6 of 12)

Error Number	Error Description [description/explanation/examples]
5058	desc = "Out of memory" help = "The OSA has run out of execution memory. An internal function was aborted due to lack of execution memory. The correction for this problem is to cycle power."
5059	desc = "Trajectory align: marginal input signal" help = "The trajectory align procedure was aborted due to an input signal with marginal amplitude. The input signal was large enough when the function began it's operation but later became too small. This usually happens when the signal is on the edge of being too small. To correct this problem increase the input signal level. If this is not possible then a slight increase in signal level can sometimes be achieved by cleaning optical fiber connectors."
5060	desc = "Trajectory align failed" help = "The trajectory align procedure failed. The trajectory adjustments computed were invalid. This is usually occurs after the OSA has received a large mechanical shock. To correct this problem try the trajectory align procedure again. If the error persists, contact the Agilent support center nearest your location."
5061	desc = "Invalid marker trace" help = "The marker could not be positioned. The marker is on a trace which does not contain any valid data. This is sometimes caused by a trace math result which is invalid."
5062	desc = "ADC Triggered Sweep Too Fast" help = "A sweep was taken with one of the ADC trigger modes enabled. The sweep rate was too fast to allow trace data to be acquired for every wavelength. To resolve this problem increase sweep time or increase the frequency the external trigger input signal."
5063	desc = "Key disabled during applications" help = "The key you pressed is not active while an application is running. Exiting the application should re-enable the key."
5064	desc = "Invalid measurement file" help = "An attempt was made to recall a measurement file which is contains invalid or corrupt data."
5065	desc = "Error detected in DSP sub-system" help = "The Digital Signal Processor has reported an unexpected error. Please record the hexadecimal number listed with the error and cycle power. If the error persists, contact the Agilent support center nearest your location."

Table 5-6. OSA Warnings (7 of 12)

Error Number	Error Description [description/explanation/examples]
5066	<p>desc = "Error in Enhanced Wavelength Calibration"</p> <p>help = "Enhanced Wavelength Calibration failed. Check OSA system. If the error persists, contact the Agilent Service Center."</p>
5067	<p>desc = "OSNR marker not allowed."</p> <p>help = "A request was made to enable the OSNR marker readout. The readout cannot be enabled for one of the following reasons: OSNR markers cannot be used on traces which have X axis units other than meters. This typically occurs in zero span where the X axis units are seconds. OSNR marks cannot be used on traces which have Y axis units other than power. this typically happens when trace math is on and the trace Y axis represents a ratio."</p>
5068	<p>desc = "The configured SHARE does not exist."</p> <p>help = "A request was made to a remote file or printer share that does not exist or cannot be found."</p>
5069	<p>desc = "The configured SHARE cannot be accessed."</p> <p>help = "A request was made to a remote file or printer share that cannot be accessed using the configured USER, PASSWORD, or DOMAIN/WORKGROUP."</p>
5070	<p>desc = "Trajectory add failed."</p> <p>help = "The trajectory add procedure failed. This usually occurs when the trajectory table is full or the computed trajectory table is invalid. To correct this problem, try AUTO ALIGN PRESET and the AUTO ALIGN & ADD TO TRAJECTORY procedure again. If the error persists, contact the Agilent Service Center."</p>
6700	<p>desc = "Math expression input parameter undefined."</p> <p>help = "A math expression could not be evaluated because one or more input arguments are undefined. Please check the spelling of all input arguments."</p>
6701	<p>desc = "Math expression input parameter has error."</p> <p>help = "A math expression could not be evaluated because an error is present on one or more of the input arguments. The error must be cleared before the expression can be evaluated."</p>
6702	<p>desc = "Math expression parameter has zero length."</p> <p>help = "A math expression could not be evaluated because one or more input arguments has a zero length. This is often caused when the subset of a trace contains no points such as when advanced line marker functions are turned on and the line markers are too close together. It can also be caused when peak/pit searches find no peaks or pits."</p>

Status Listings
OSA Warnings

Table 5-6. OSA Warnings (8 of 12)

Error Number	Error Description [description/explanation/examples]
6720	desc = "Math expression input parameter has error." help = "A math expression could not be evaluated because of improper input arguments. This could be due to one or more input arguments having the wrong type or size or because one or more inputs are not defined."
6721	desc = "Internal error in marker search" help => "A marker search function has failed due to an internal software problem. Please try the operation again. If the error persists, contact the Agilent support center nearest your location."
6722	desc = "Math expression input cannot be boolean." help = "A math expression could not be evaluated because one or more of the input arguments is boolean. This function does not allow boolean input arguments."
6723	desc = "Trace X axis values do not match." help = "A math expression could not be evaluated because the input arguments have differing X axis values. This function requires that all input arguments have identical X axis values. All trace inputs must be taken with identical start/stop settings."
6724	desc = "Error in source trace" help => "The source trace has an error. The error may possibly be that the source trace contains no points. Please try the operation again. If the error persists, contact the Agilent support center nearest your location."
6725	desc = "Trace lengths do not match." help = "A math expression could not be evaluated because the inputs have differing sizes (trace lengths). All inputs to this function must be of the same size."
6726	desc = "Trace lengths do not match." help = "A math expression could not be evaluated because the inputs have differing sizes (trace lengths). All inputs to this function must be of the same size."
6727	desc = "Y axis counts do not match." help = "A math expression could not be evaluated because the inputs have differing numbers of Y axis data. All input arguments to this function must have the same number of Y axis data points."
6728	desc = "Incorrect number of inputs for math expression" help = "A math expression could not be evaluated because the number of input arguments to the function is incorrect."

Table 5-6. OSA Warnings (9 of 12)

Error Number	Error Description [description/explanation/examples]
6729	<p>desc = "Math expression expects units of dBm." help = "A math expression could not be evaluated because the input argument does not have the required Y axis units of dBm."</p>
6730	<p>desc = "Math expression expects units of watts." help = "A math expression could not be evaluated because the input argument does not have the required Y axis units of watts."</p>
6731	<p>desc = "Illegal combination of trace Y axis units" help = "A math expression could not be evaluated because the combination of Y axis units in the input arguments do not make sense. For example it is valid to divide watts by watts or to divide watts by a unitless value but it is invalid to divide a unitless value by watts."</p>
6732	<p>desc = "Illegal combination of trace X axis units" help = "A math expression could not be evaluated because the input arguments have differing X axis units. All input arguments must have identical X axis units. This commonly happens when trace math is attempted between a zero span trace (time units) and a non-zero span trace (wavelength units)."</p>
6733	<p>desc = "Invalid combination of Y axis units" help = "A math expression could not be evaluated because of an invalid combination of Y axis units. The math operation being performed only allows one of the arguments to have units. All other arguments must be unitless. The math operator is shown in parenthesis in the short message above. For example multiplying a trace in watts (dBm) by another trace in watts (dBm) is not permitted."</p>
6734	<p>desc = "Too many inputs have Y axis units" help = "A math expression could not be evaluated because of an invalid combination of inputs. Only one input argument is allowed to have non-blank Y axis units."</p>
6735	<p>desc = "Trace has too many Y axes" help = "A math expression could not be evaluated because of an invalid input. One of the arguments contains multiple sets of Y data. Only one set of Y data is allowed for this math function."</p>
6736	<p>desc = "Math expression expects boolean inputs." help = "A math expression could not be evaluated because of an invalid input. The math function requires all of it's arguments to be boolean. At least one of the arguments is not boolean."</p>

Status Listings
OSA Warnings

Table 5-6. OSA Warnings (10 of 12)

Error Number	Error Description [description/explanation/examples]
6737	desc = "Invalid math constant" help = "During evaluation of a math expression an invalid constant was encountered. The constant has undefined or default settings for it's X and/or Y values."
6738	desc = "Out of memory" help = "A trace or math operation was requested. There is insufficient memory available to perform the operation. Try reducing trace length or cycle power."
6739	desc = "Too many peaks or pits" help = "A marker search operation was requested. There are too many valid pits or peaks in the current trace. Reduce the number of valid pits or peaks by increasing the peak or pit excursion setting."
6741	desc = "Constant with multiple Y values" help = "During evaluation of a math expression a constant was encountered which contains more than one Y value. Constants are only permitted to have one Y value."
6742	desc = "Requested amplitude not found" help = "A math expression to search for a specific amplitude in a trace did not succeed. There are no trace points with the desired amplitude."
6744	desc = "Excursion should be in dB" help = "The units for the excursion are not in dB."
6745	desc = "Log of a negative number is not allowed." help = "During evaluation of a math expression the logarithm of a negative number was encountered."
6746	desc = "Math expression contains a circular reference." help = "A new math expression was entered. The expression was rejected because it would create a circular reference. For example if trace math for trace C is set to (A-B) then setting trace math for trace B to (C+D) would create a circular reference."
6747	desc = "Next peak not found" help = "A next-peak search was requested. There are no more peaks on the current marker's trace in the requested direction. To find additional peaks reduce the marker peak excursion setting or adjust sensitivity."
6748	desc = "Next pit not found" help = "A next-pit search was requested. There are no more pits on the current marker's trace in the requested direction. To find additional pits reduce the marker pit excursion setting or adjust sensitivity."

Table 5-6. OSA Warnings (11 of 12)

Error Number	Error Description [description/explanation/examples]
6749	<p>desc = "Peak not found"</p> <p>help = "A peak search was requested. There are no valid peaks on the current marker's trace. Try decreasing the marker peak excursion setting or adjust the sensitivity setting."</p>
6750	<p>desc = "Pit not found"</p> <p>help = "A pit search was requested. There are no valid pits on the current marker's trace. Try decreasing the marker pit excursion setting or adjust the sensitivity setting."</p>
6751	<p>desc = "Trace has no centroid"</p> <p>help = "The trace has no centroid. This may occur because the sum of trace points' amplitudes is zero or there a no trace points."</p>
6752	<p>desc = "The reference point is outside trace bounds"</p> <p>help = "The reference point's wavelength is either too small or too large. The reference point will be clipped to a trace endpoint."</p>
6753	<p>desc = "The window specified is invalid."</p> <p>help = "The window specified is invalid. The window should be a constant."</p>
6754	<p>desc = "Search failed: no data"</p> <p>help = "A marker search operation was requested. After clipping the trace data to screen limits and line marker limits (if enabled) there was no data to search. This can be caused when all trace data points are beyond current X axis screen limits or when there are no trace data points between the line markers. Trace data values which exceed the current Y axis screen limits will not cause this problem. Adjust the current X axis screen limits and/or move the line markers to include at least one trace data point."</p>
6755	<p>desc = "Attempt to divide by 0"</p> <p>help = "At least one point was attempted to be divided by 0. The result for these divisions has been set to not-a-number. Please realize that further calculations with not-a-number values are undefined."</p>
6756	<p>desc = "Syntax error; bad token: "</p> <p>help = "The grammar expression entered cannot be parsed. Please check the string entered. The bad token attempts to indicate where the error occurred. The end of line indicates that the OSA expected more information. Please consult the manual for additional help."</p>
7998	<p>desc = "Unknown error detected"</p> <p>help = "An unlisted error was reported by the instrument software. If this error persists contact Agilent Technologies for assistance."</p>

Status Listings
OSA Warnings

Table 5-6. OSA Warnings (12 of 12)

Error Number	Error Description [description/explanation/examples]
7999	desc = "The warning list has overflowed" help = "The Warning list has overflowed. The last entries received have been deleted."

Application-Specific Warnings

Table 5-7. Application-Specific Warnings (1 of 6)

Error Number	Error Description [description/explanation/examples]
8001	<p>desc = "Incorrect application type is listed in spec file." help = "The application expects the first non-comment line of the specification file to contain the APPLICATION keyword followed by the application type. Either the APPLICATION keyword was missing or the wrong application type was specified for this particular application."</p>
8002	<p>desc = "A keyword cannot be used as a variable name." help = "The application has a list of keywords reserved for specification file use. These reserved words cannot be used as a name for one of the measurement parameters."</p>
8003	<p>desc = "The variable name has already been used." help = "The application allows new names to be assigned to measurement parameters. Once assigned these names can only be used as inputs to other measurements. Only the first ten characters are significant. The line number indicates where the problem was found. The word in the parentheses is the variable name causing the problem."</p>
8004	<p>desc = "Wrong number of input parameters." help = "The wrong number of inputs were found for a specification file command. The line number listed is where the problem was found in the specification file. The first number in parentheses is the number of inputs found and the second number is the number of inputs required."</p>
8005	<p>desc = "An input parameter has the wrong units." help = "One of the input parameters to the specification file has the wrong units specified. The line number listed is where the problem was found in the specification file. The first units listed in the parentheses was the units used by the parameter and the second units is the units required by the parameter. An empty pair of quotes "" indicates unitless."</p>

Status Listings
Application-Specific Warnings

Table 5-7. Application-Specific Warnings (2 of 6)

Error Number	Error Description [description/explanation/examples]
8006	desc = "The specification file cannot be imported." help = "An error occurred while trying to import the specification file. Refer to the previous warnings for more information on specific errors in the specification file."
8007	desc = "The specification file has a syntax error." help = "One of the specification file lines has a syntax problem. The problem occurred on the line number listed. The string in the parentheses caused the problem."
8008	desc = "A variable was used where a constant is expected." help = "A variable name was used as a parameter where only a constant value or the DEFAULT keyword is allowed. The line number indicates where the problem was found. The variable name in the parentheses caused the problem."
8009	desc = "The variable name has not been defined." help = "An undefined variable name was used as a parameter for a specification. All variables used as parameters must be defined in a specification statement preceding the variable's use. The line number indicates where the problem was found. The variable name in the parentheses is the undefined variable."
8010	desc = "A variable can be used only once per statement." help = "A variable name was used as multiple parameters for the same specification statement. The input parameter was ignored because using multiple references is not allowed. The line number indicates where the problem was found. The variable name in the parentheses is the variable causing the problem."
8011	desc = "A keyword was used where a variable is expected." help = "The application specification file has a list of reserved words which are used to specify the measurements to be made. These keywords cannot be used as input parameters for specification statements. The input parameter was ignored for this case. The line number indicates where the problem was found. The word in the parentheses is the reserved word causing the problem."
8012	desc = "A label is required to identify the spec file." help = "The label string is used to identify the specification file. It is required after specifying the application type. An empty string (pair of double quotes) is acceptable input."
8013	desc = "The specification file cannot be exported." help = "An error occurred while trying to export the specification file."

Table 5-7. Application-Specific Warnings (3 of 6)

Error Number	Error Description [description/explanation/examples]
8014	<p>desc = "Print statement ignored: no path is specified"</p> <p>help = "The PRINT statement needs to be after a PATH statement to indicate which PATH data is to be printed. The PRINT statement at the line number specified came before any PATH statement. This PRINT statement will not trigger any printouts."</p>
8015	<p>desc = "DEFAULT cannot be used for a parameter."</p> <p>help = "A parameter cannot be specified as DEFAULT. The parameter needs to be either a previously defined variable name or an actual value. The bad parameter was found on the line number specified. The number in the parentheses is the number of the parameter causing the problem."</p>
8016	<p>desc = "A duplicate command is in the spec file."</p> <p>help = "Certain commands should be used only once in the specification file. The duplicate command was found on the line number specified. The command in the parentheses is the duplicate."</p>
8017	<p>desc = "A required command is missing from the spec file."</p> <p>help = "Certain commands must be used in the specification file. The missing command is listed in the parentheses. This command should be used only once in the file."</p>
8018	<p>desc = "The normalization interval limited to maximum."</p> <p>help = "The normalization interval has a maximum value of 24 and a minimum value of 0.1 hours. The interval specified in the specification file is outside this range. The specification file can still be used but the calibration interval will be 24 hours."</p>
8019	<p>desc = "The spec file could not be loaded."</p> <p>help = "The application found a problem with the specification file. Possible causes can include the following: the file is incompatible with the application the file is from a previous version of the application the file was corrupted. The file with the problem is specified within the parentheses. Try re-importing the specification file."</p>
8020	<p>desc = "The default spec file was loaded."</p> <p>help = "The default specification file for the application was loaded. This is done when the application is first started or if a problem occurred when trying to load another specification file. Refer to the previous warnings for information on any problems loading another file."</p>
8021	<p>desc = "The spec file could not be found."</p> <p>help = "The application tried to load a specification file which could not be found in the internal memory. This may have occurred if the last file used by the application was deleted. The filename is specified within the parentheses."</p>

Status Listings
Application-Specific Warnings

Table 5-7. Application-Specific Warnings (4 of 6)

Error Number	Error Description [description/explanation/examples]
8022	desc = "A closing quote is missing." help = "The specification file contained a line with an opening quote but no closing quote could be found."
8023	desc = "A default path name was used." help = "The imported specification file was given a default path name. All specification files must have at least one PATH statement before any of the measurement statements. A default path name was used either because some measurement statements were used before a PATH statement or there was no PATH statement at all in the file."
8024	desc = "A variable is expected." help = "The statement expected a variable as an input parameter. The line number indicates which statement did not have the proper input parameter type."
8025	desc = "The path name has already been used." help = "The application allows new names to be assigned to measurement paths. Once assigned these names can no longer be used by other measurement paths. Only the first thirty-two characters are significant. The line number indicates where the problem was found. The word in the parentheses is the path name causing the problem."
8026	desc = "A path name was used where a variable is expected." help = "The input parameters for measurement statements can take variables as inputs. These variables are the results of other measurement statements. A path name is the name of a measurement path not the result of a measurement and cannot be used as an input parameter. The input parameter was ignored for this case. The line number indicates where the problem was found. The word in the parentheses is the path name causing the problem."
8027	desc = "A parameter value was outside the legal range." help = "A parameter value was used which was outside the allowable range. The first number in the parentheses is the number of the parameter causing the problem. The other two numbers are the minimum and maximum values allowed. These values are in base units (e.g meters watts)."
8028	desc = "A minimum non-zero span is required." help = "The application cannot run in a zero span setting. The start and stop wavelength must be separated by a minimum span. The line number indicates the line in the specification file which had a start and stop wavelength pair that did not meet the minimum span requirement."

Table 5-7. Application-Specific Warnings (5 of 6)

Error Number	Error Description [description/explanation/examples]
8029	<p>desc = "The requested function is not yet implemented." help = "The statement within the specification file is not implemented in this version of the application. The word in parentheses has been reserved for future use. The statement at the specified line number needs to be removed before the specification file can be imported."</p>
8030	<p>desc = "A SETUP statement is needed before SWEEP." help = "The wavelength limits of the SWEEP statement are checked against the wavelength limits in the SETUP statement. This check requires that the SETUP statement occur before the SWEEP statement. The line number indicates which SWEEP statement is not preceded by the SETUP statement."</p>
8031	<p>desc = "The SWEEP limits are outside the SETUP range." help = "The start and stop values for the SWEEP statement must be within the start and stop values of the SETUP statement. The line number indicates which SWEEP statement has values out of range. The number in the parentheses indicates which parameter is out of range."</p>
8032	<p>desc = "The units of the inputs are not compatible." help = "The units of the inputs to a math operation need to be compatible with the operation desired. Addition and subtraction need to have matching units. Multiplication needs to have a unitless parameter. Division needs a unitless denominator or the units for the numerator and denominator need to match. The line number indicates which statement had the mismatched input units."</p>
8033	<p>desc = "The reference point is outside the SETUP range." help = "The reference point value must be within the start and stop values of the SETUP statement. The line number indicates which statement had the value out of range."</p>
8034	<p>desc = "The values are associated with different axes." help = "The variables used in a basic math operation like ADD or DIV must be associated with the same data axis (e.g. wavelength or amplitude). Mixing the axes values within a single math operation is not allowed. The line number indicates which statement had the incompatible variables."</p>
8035	<p>desc = "The search limits are outside the SETUP range." help = "The search limits for statements like PEAK or CENTER_OF_MASS must be within the start and stop values of the SETUP statement. The line number indicates which statement has values out of range. The number in the parentheses indicates which parameter is out of range."</p>

Status Listings
Application-Specific Warnings

Table 5-7. Application-Specific Warnings (6 of 6)

Error Number	Error Description [description/explanation/examples]
8036	desc = "The specification units do not match." help = "The units for the minimum and maximum specification values need to match. The line number indicates which statement has the mismatching units."
8037	desc = "The specification units do not match the input units." help = "The units for the minimum and maximum specification values need to match the units for the input parameters. The line number indicates which statement has the mismatching units."

OSA Status Errors

Table 5-8. OSA Status Errors

Error Number	Error Description [description/explanation/examples]
10000	desc = "Sweep Uncalibrated" help = "The current setting of sweep time may be too fast. This could result in an invalid measurement. In certain cases it is possible to sweep faster than the coupled sweep time without compromising measurement accuracy. Please refer to the users manual and relevant application notes for more information."
11998	desc = "Too Many Hardware Status Errors" help = "The Hardware Status Error list has overflowed. Additional more recent items have been deleted."

OSA Errors

Table 5-9. OSA Errors (1 of 2)

Error Number	Error Description [description/explanation/examples]
20001	<p>desc = "Error detected in ADC sub-system"</p> <p>help = "An error has been detected in the Analog-to-Digital converter subsystem. Please record the hexadecimal number listed with the error and cycle power. If the error persists, contact the nearest Agilent Technologies Instrument support center for assistance. In the U.S., call (800) 403-0801. See the <i>Agilent 86140B Series Users Guide</i> for a listing of the Agilent sales and service offices."</p>
20002	<p>desc = "Error detected in slit positioning system"</p> <p>help = "An error has been detected in the motor which controls the resolution bandwidth slit wheel. Please record the hexadecimal number listed with the error and cycle power. If the error persists, contact the nearest Agilent Technologies Instrument support center for assistance. In the U.S., call (800) 403-0801. See the <i>Agilent 86140B Series Users Guide</i> for a listing of the Agilent sales and service offices."</p>
20003	<p>desc = "Error detected in grating positioning system"</p> <p>help = "An error has been detected in the motor which controls the diffraction grating. Please record the hexadecimal number listed with the error and cycle power. If the error persists, contact the nearest Agilent Technologies Instrument support center for assistance. In the U.S., call (800) 403-0801. See the <i>Agilent 86140B Series Users Guide</i> for a listing of the Agilent sales and service offices."</p>
20004	<p>desc = "Monochromator calibration data is invalid"</p> <p>help = "Factory calibration data for the monochromator is invalid. Please record the hexadecimal number listed with the error and cycle power. If the error persists, contact the nearest Agilent Technologies Instrument support center for assistance. In the U.S., call (800) 403-0801. See the <i>Agilent 86140B Series Users Guide</i> for a listing of the Agilent sales and service offices."</p>

Table 5-9. OSA Errors (2 of 2)

Error Number	Error Description [description/explanation/examples]
20005	<p>desc = "Trans-Impedance calibration data is invalid"</p> <p>help = "Factory calibration data for the trans-impedance amplifier is invalid. Please record the hexadecimal number listed with the error and cycle power. If the error persists, contact the nearest Agilent Technologies Instrument support center for assistance. In the U.S., call (800) 403-0801. See the <i>Agilent 86140B Series Users Guide</i> for a listing of the Agilent sales and service offices."</p>
20006	<p>desc = "Monochromator flatness calibration data is invalid"</p> <p>help = "Factory flatness data for the monochromator is invalid. Please record the hexadecimal number listed with the error and cycle power. If the error persists, contact the nearest Agilent Technologies Instrument support center for assistance. In the U.S., call (800) 403-0801. See the <i>Agilent 86140B Series Users Guide</i> for a listing of the Agilent sales and service offices."</p>
20007	<p>desc = "Sweep Timeout"</p> <p>help = "A sweep was started but did not finish in the expected amount of time. The trace data acquired during this sweep may not be valid. Try taking another sweep. If the error persists, contact the nearest Agilent Technologies Instrument support center for assistance. In the U.S., call (800) 403-0801. See the <i>Agilent 86140B Series Users Guide</i> for a listing of the Agilent sales and service offices."</p>
21999	<p>desc = "The Error list has overflowed"</p> <p>help = "The Error list has overflowed. The last entries received have been deleted."</p>

Firmware Errors

Table 5-10. Firmware Errors

Error Number	Error Description [description/explanation/examples]
30000	desc = "Internal Communications Error" help = "An internal software error has occurred involving communications between different software processes. Please record this error including the extra text and cycle power. If the error persists, contact the nearest Agilent Technologies Instrument support center for assistance. In the U.S., call (800) 403-0801. See the <i>Agilent 8614x series Users Guide</i> for a listing of the Agilent sales and service offices."
30001	desc = "Auto-Measure Software Error" help = "An error has been detected in the auto-measure software. There is an internal problem with the software. Please make a note of the text in parentheses at the end of the error message and cycle power. If the error persists, contact the nearest Agilent Technologies Instrument support center for assistance. In the U.S., call (800) 403-0801. See the <i>Agilent 8614x series Users Guide</i> for a listing of the Agilent sales and service offices."

6

Changing the Printer Paper	6-2
Cleaning Connections for Accurate Measurements	6-8
Returning the Instrument for Service	6-21

Maintenance

Changing the Printer Paper

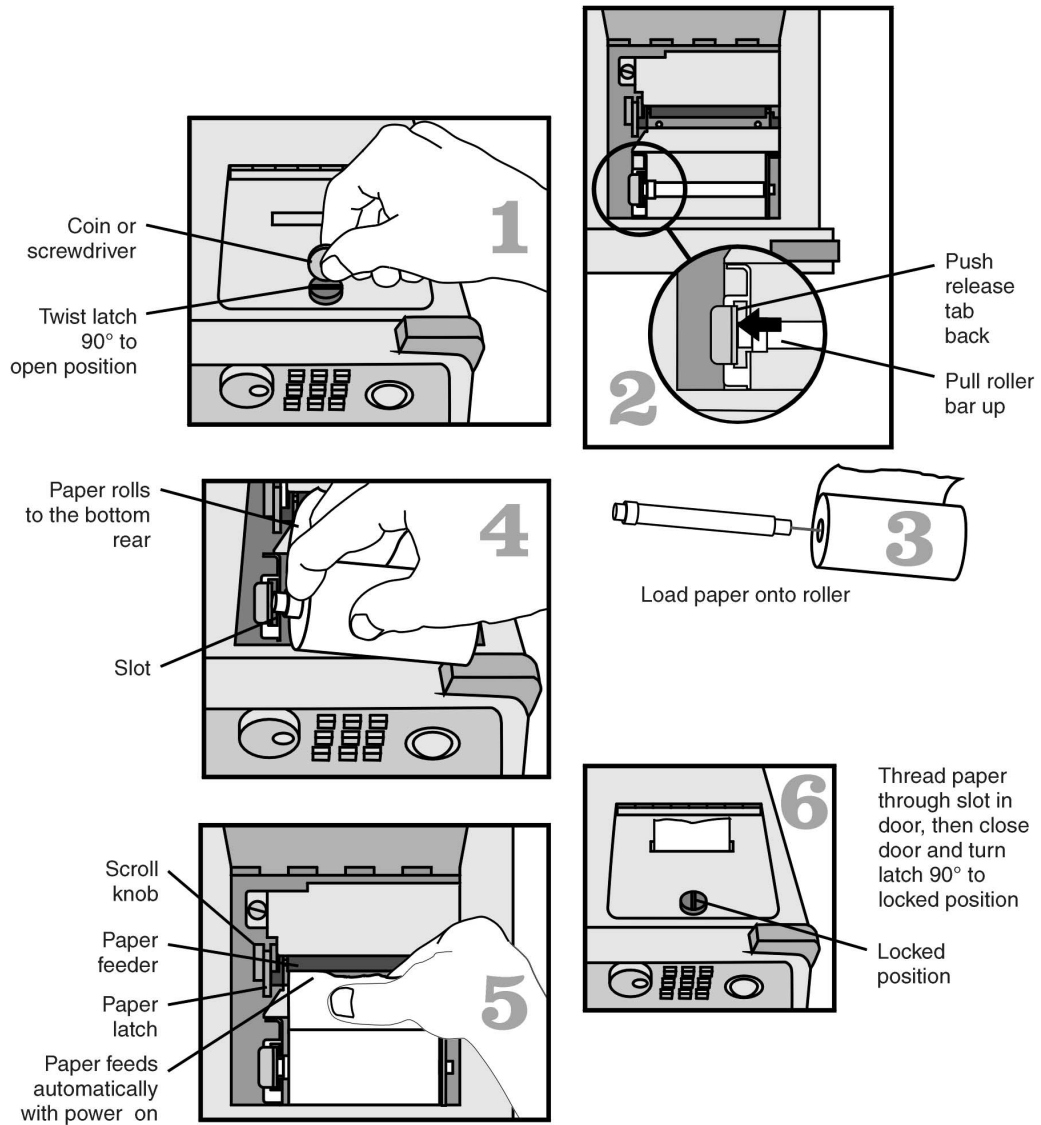

loadpaper

CAUTION Avoid dropping the coin or screwdriver, used to open the printer door, into the printer assembly.

CAUTION Always use Agilent brand paper to ensure quality printing and long printer life. Order paper as Agilent part number 9270-1370.

CAUTION Never use the printer without printer paper as this can damage the printer head.

- If the instrument is on, the paper feeder automatically scrolls whenever paper is inserted into the feeder.
- Lift the paper latch to correct paper alignment problems. The scroll knob allows you to manually advance the paper.

CAUTION To avoid damage caused by losing parts and tools inside the instrument, always turn the instrument off *before* installing the printer paper.

Printer Head Cleaning Procedure

Lint from normal use of the printer may eventually collect on the printer head and degrade print quality. Use the procedure provided in this section to clean the printer head. Also refer to "Changing the Printer Paper" on page 6-2.

WARNING

This servicing procedure is for use by qualified personnel only. To avoid electrical shock, do not perform this procedure unless you are qualified to do so.

CAUTION

Electrostatic discharge (ESD) can damage or destroy the printer. Therefore, this procedure must always be performed at a static-safe work station.

Static-safe Work Station

Figure 6-1 on page 6-5 shows an example of a static-safe work station using conductive table and floor mats and wrist and heel straps. To ensure user safety, the static-safe accessories must provide at least 1 MW of isolation from ground. Refer to Table 6-1 for information on ordering static-safe accessories.

Table 6-1. Static-Safe Accessories

Agilent Part Number	Description
9300-0797	3M static control mat 0.6 m x 1.2 m (2 ftx 4 ft) and 4.6 cm (15 ft) ground wire. (The wrist-strap and wrist-strap cord are not included. They must be ordered separately.)
9300-0980	Wrist-strap cord 1.5 m (5 ft).

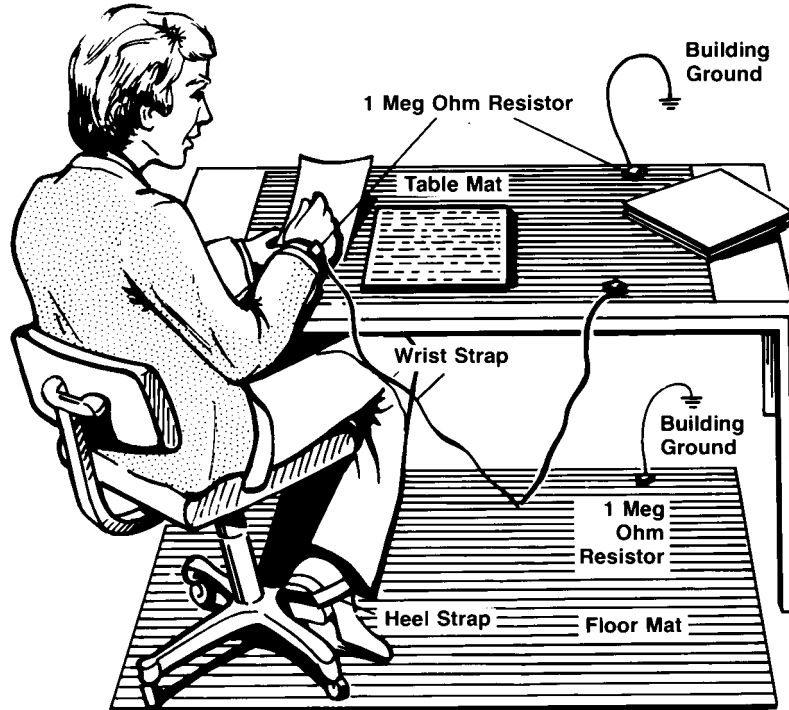

Figure 6-1. Example of a static-safe workstation

To clean the printer head

Table 6-2. Printer Accessories

Agilent Part Number	Description
9270-1605	Printer Paper

- 1 Turn off the Agilent 86140B series optical spectrum analyzer, and remove the line power cord.
- 2 Place the instrument at a static-safe work station as described in the introduction to this procedure.
- 3 Use a coin or screwdriver to open the printer door that is located on the top of the instrument.

CAUTION

Avoid dropping the coin or screwdriver, used to open the printer door, into the printer assembly.

- 4 Lift up the paper latch as shown in the following diagram, and remove the paper.

Maintenance
Printer Head Cleaning Procedure

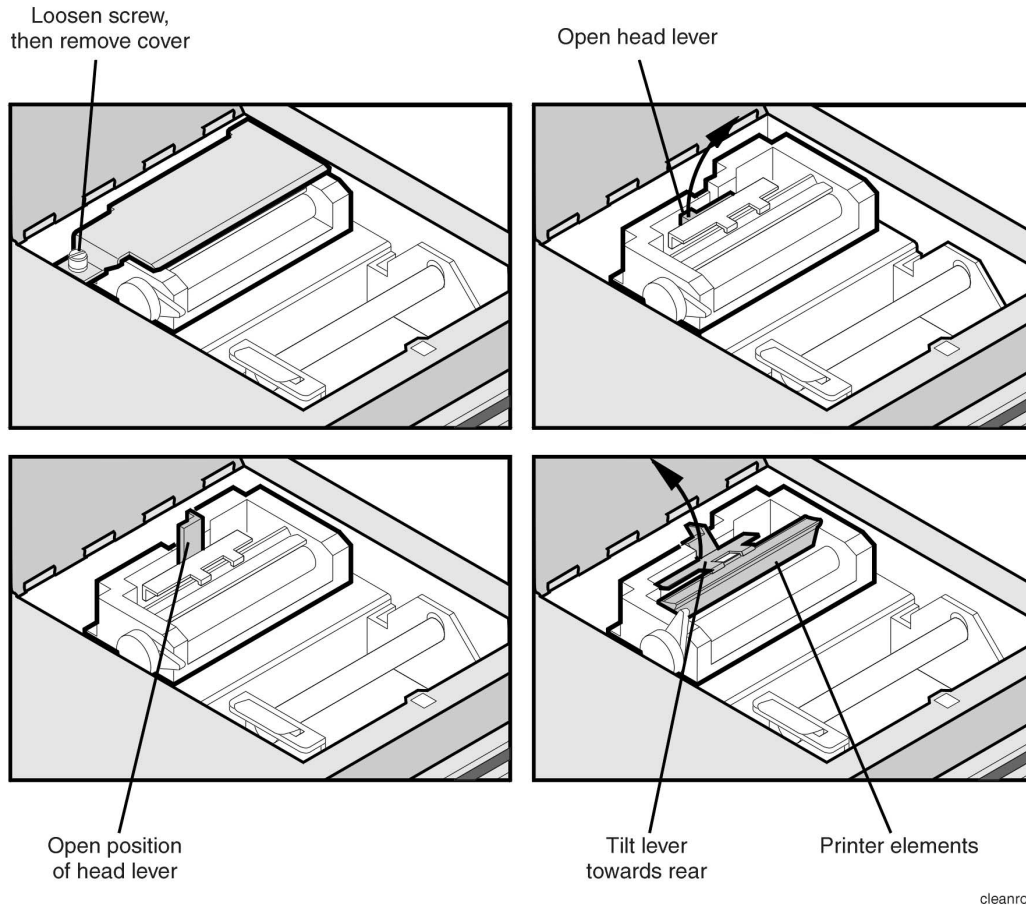

- 5 Unscrew the retaining screw that secures the sheet-metal cover that protects the printer head from electrostatic discharge. Slide the sheet-metal cover towards the retaining screw and then lift it straight up to remove.
- 6 Lift the printer head lever to the vertical position. Then, tilt the lever towards the instrument's rear panel to rotate the printer head up.
- 7 Clean the printer head using a cotton swab and isopropyl alcohol.

CAUTION

Use of other cleaning materials or fluids may damage the printer.

- 8 After the printer head has thoroughly dried, use the printer head lever to return the printer head to its original position.

- 9 Replace and secure the sheet-metal cover for the printer head.
- 10 Replace the printer paper, and close the printer access door.

Cleaning Connections for Accurate Measurements

Today, advances in measurement capabilities make connectors and connection techniques more important than ever. Damage to the connectors on calibration and verification devices, test ports, cables, and other devices can degrade measurement accuracy and damage instruments. Replacing a damaged connector can cost thousands of dollars, not to mention lost time! This expense can be avoided by observing the simple precautions presented in this book. This book also contains a brief list of tips for caring for electrical connectors.

Choosing the Right Connector

A critical but often overlooked factor in making a good lightwave measurement is the selection of the fiber-optic connector. The differences in connector types are mainly in the mechanical assembly that holds the ferrule in position against another identical ferrule. Connectors also vary in the polish, curve, and concentricity of the core within the cladding. Mating one style of cable to another requires an adapter. Agilent Technologies offers adapters for most instruments to allow testing with many different cables. Figure 6-2 on page 6-9 shows the basic components of a typical connectors.

The system tolerance for reflection and insertion loss must be known when selecting a connector from the wide variety of currently available connectors. Some items to consider when selecting a connector are:

- How much insertion loss can be allowed?
- Will the connector need to make multiple connections? Some connectors are better than others, and some are very poor for making repeated connections.
- What is the reflection tolerance? Can the system take reflection degradation?

- Is an instrument-grade connector with a precision core alignment required?
- Is repeatability tolerance for reflection and loss important? Do your specifications take repeatability uncertainty into account?
- Will a connector degrade the return loss too much, or will a fusion splice be required? For example, many DFB lasers cannot operate with reflections from connectors. Often as much as 90 dB isolation is needed.

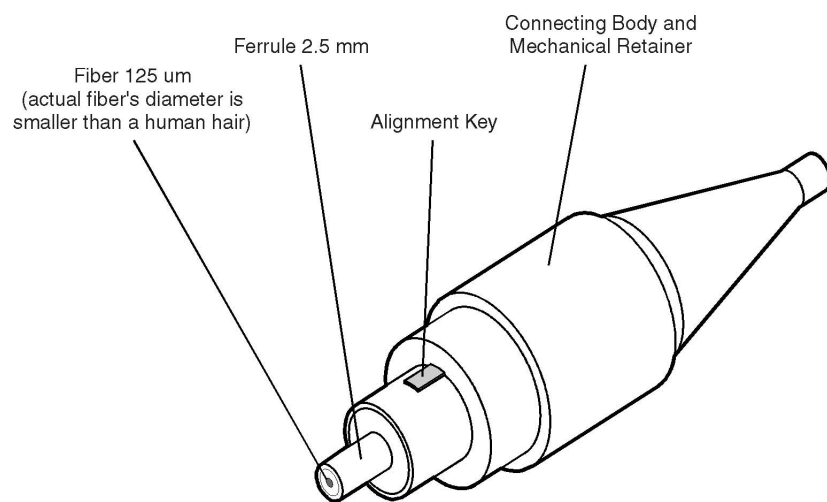

Figure 6-2. Basic components of a connector.

Over the last few years, the FC/PC style connector has emerged as the most popular connector for fiber-optic applications. While not the highest performing connector, it represents a good compromise between performance, reliability, and cost. If properly maintained and cleaned, this connector can withstand many repeated connections.

However, many instrument specifications require tighter tolerances than most connectors, including the FC/PC style, can deliver. These instruments cannot tolerate connectors with the large non-concentricities of the fiber common with ceramic style ferrules. When tighter alignment is required, Agilent Technologies instruments typically use a connector such as the Diamond HMS-10, which has concentric tolerances within a few tenths of a micron. Agilent Technologies then uses a special universal adapter, which allows other cable types to mate with this precision connector. See Figure 6-3.

Maintenance

Cleaning Connections for Accurate Measurements



Figure 6-3. Universal adapters to Diamond HMS-10.

The HMS-10 encases the fiber within a soft nickel silver (Cu/Ni/Zn) center which is surrounded by a tough tungsten carbide casing, as shown in Figure 6-4.

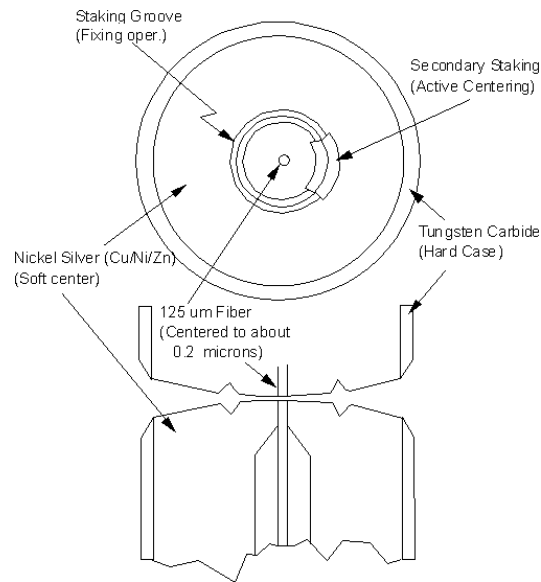

Figure 6-4. Cross-section of the Diamond HMS-10 connector.

The nickel silver allows an active centering process that permits the glass fiber to be moved to the desired position. This process first stakes the soft nickel silver to fix the fiber in a near-center location, then uses a post-active staking to shift the fiber into the desired position within 0.2 mm. This process, plus the keyed axis, allows very precise core-to-core alignments. This connector is found on most Agilent Technologies lightwave instruments.

The soft core, while allowing precise centering, is also the chief liability of the connector. The soft material is easily damaged. Care must be taken to minimize excessive scratching and wear. While minor wear is not a problem if the glass face is not affected, scratches or grit can cause the glass fiber to move out of alignment. Also, if unkeyed connectors are used, the nickel silver can be pushed onto the glass surface. Scratches, fiber movement, or glass contamination will cause loss of signal and increased reflections, resulting in poor return loss.

Inspecting Connectors

Because fiber-optic connectors are susceptible to damage that is not immediately obvious to the naked eye, poor measurements result without the user being aware. Microscopic examination and return loss measurements are the best way to ensure good measurements. Good cleaning practices can help ensure that optimum connector performance is maintained. With glass-to-glass interfaces, any degradation of a ferrule or the end of the fiber, any stray particles, or finger oil can have a significant effect on connector performance. Where many repeat connections are required, use of a connector saver or patch cable is recommended.

Figure 6-5 shows the end of a clean fiber-optic cable. The dark circle in the center of the micrograph is the fiber's 125 μm core and cladding which carries the light. The surrounding area is the soft nickel-silver ferrule. Figure 6-6 shows a dirty fiber end from neglect or perhaps improper cleaning. Material is smeared and ground into the end of the fiber causing light scattering and poor reflection. Not only is the precision polish lost, but this action can grind off the glass face and destroy the connector.

Figure 6-7 shows physical damage to the glass fiber end caused by either repeated connections made without removing loose particles or using improper cleaning tools. When severe, the damage of one connector end can be transferred to another good connector endface that comes in contact with the damaged one. Periodic checks of fiber ends, and replacing connecting cables after many connections is a wise practice.

The cure for these problems is disciplined connector care as described in the following list and in "Cleaning Connectors" on page 6-15.

Maintenance

Cleaning Connections for Accurate Measurements

Use the following guidelines to achieve the best possible performance when making measurements on a fiber-optic system:

- Never use metal or sharp objects to clean a connector and never scrape the connector.
- Avoid matching gel and oils.

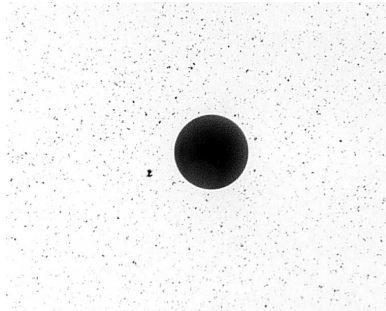

Figure 6-5. Clean, problem-free fiber end and ferrule.

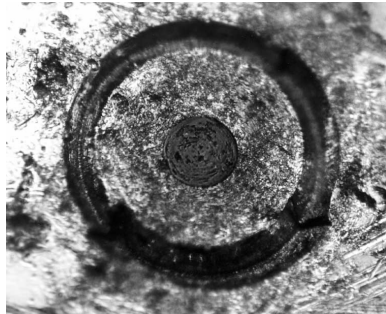

Figure 6-6. Dirty fiber end and ferrule from poor cleaning.

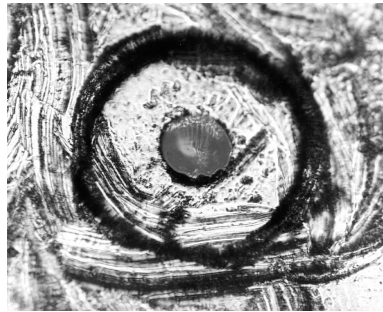

Figure 6-7. Damage from improper cleaning.

While these often work well on first insertion, they are great dirt magnets. The oil or gel grabs and holds grit that is then ground into the end of the fiber. Also, some early gels were designed for use with the FC, non-contacting connectors, using small glass spheres. When used with contacting connectors, these glass balls can scratch and pit the fiber. If an index matching gel or oil must be used, apply it to a freshly cleaned connector, make the measurement, and then immediately clean it off. Never use a gel for longer-term connections and never use it to improve a damaged connector. The gel can mask the extent of damage and continued use of a damaged fiber can transfer damage to the instrument.

- When inserting a fiber-optic cable into a connector, gently insert it in as straight a line as possible. Tipping and inserting at an angle can scrape material off the inside of the connector or even break the inside sleeve of connectors made with ceramic material.
- When inserting a fiber-optic connector into a connector, make sure that the fiber end does not touch the outside of the mating connector or adapter.
- Avoid over tightening connections.

Unlike common electrical connections, tighter is *not* better. The purpose of the connector is to bring two fiber ends together. Once they touch, tightening only causes a greater force to be applied to the delicate fibers. With connectors that have a convex fiber end, the end can be pushed off-axis resulting in misalignment and excessive return loss. Many measurements are actually improved by backing off the connector pressure. Also, if a piece of grit does happen to get by the cleaning procedure, the tighter connection is more likely to damage the glass. Tighten the connectors just until the two fibers touch.

Maintenance

Cleaning Connections for Accurate Measurements

- Keep connectors covered when not in use.
- Use fusion splices on the more permanent critical nodes. Choose the best connector possible. Replace connecting cables regularly. Frequently measure the return loss of the connector to check for degradation, and clean every connector, every time.

All connectors should be treated like the high-quality lens of a good camera. The weak link in instrument and system reliability is often the inappropriate use and care of the connector. Because current connectors are so easy to use, there tends to be reduced vigilance in connector care and cleaning. It takes only one missed cleaning for a piece of grit to permanently damage the glass and ruin the connector.

Measuring insertion loss and return loss

Consistent measurements with your lightwave equipment are a good indication that you have good connections. Since return loss and insertion loss are key factors in determining optical connector performance they can be used to determine connector degradation. A smooth, polished fiber end should produce a good return-loss measurement. The quality of the polish establishes the difference between the "PC" (physical contact) and the "Super PC" connectors. Most connectors today are physical contact which make glass-to-glass connections, therefore it is critical that the area around the glass core be clean and free of scratches. Although the major area of a connector, excluding the glass, may show scratches and wear, if the glass has maintained its polished smoothness, the connector can still provide a good low level return loss connection.

If you test your cables and accessories for insertion loss and return loss upon receipt, and retain the measured data for comparison, you will be able to tell in the future if any degradation has occurred. Typical values are less than 0.5 dB of loss, and sometimes as little as 0.1 dB of loss with high performance connectors. Return loss is a measure of reflection: the less reflection the better (the larger the return loss, the smaller the reflection). The best physically contacting connectors have return losses better than 50 dB, although 30 to 40 dB is more common.

Visual inspection of fiber ends

Visual inspection of fiber ends can be helpful. Contamination or imperfections on the cable end face can be detected as well as cracks or chips in the fiber itself. Use a microscope (100X to 200X magnification) to inspect the entire end face for contamination, raised metal, or dents in the metal as well as any other imperfections. Inspect the fiber for cracks and chips. Visible imperfections not touching the fiber core may not affect performance (unless the imperfections keep the fibers from contacting).

WARNING

Always remove both ends of fiber-optic cables from any instrument, system, or device before visually inspecting the fiber ends. Disable all optical sources before disconnecting fiber-optic cables. Failure to do so may result in permanent injury to your eyes.

Cleaning Connectors

The procedures in this section provide the proper steps for cleaning fiber-optic cables and Agilent Technologies universal adapters. The initial cleaning, using the alcohol as a solvent, gently removes any grit and oil. If a caked-on layer of material is still present, (this can happen if the beryllium-copper sides of the ferrule retainer get scraped and deposited on the end of the fiber during insertion of the cable), a second cleaning should be performed. It is not uncommon for a cable or connector to require more than one cleaning.

CAUTION

Agilent Technologies strongly recommends that index matching compounds *not* be applied to their instruments and accessories. Some compounds, such as gels, may be difficult to remove and can contain damaging particulates. If you think the use of such compounds is necessary, refer to the compound manufacturer for information on application and cleaning procedures.

Table 6-3. Cleaning Accessories

Item	Agilent Part Number
Cotton swabs	8520-0023
Small foam swabs	9300-1223

Maintenance
Cleaning Connections for Accurate Measurements

Table 6-4. Dust Caps Provided with Lightwave Instruments

Item	Agilent Part Number
Laser shutter cap	08145-64521
FC/PC dust cap	08154-44102
ST dust cover	1401-0291

To clean a non-lensed connector

CAUTION

Do not use any type of foam swab to clean optical fiber ends. Foam swabs can leave filmy deposits on fiber ends that can degrade performance.

- 1 Apply pure isopropyl alcohol to a clean lint-free cotton swab or lens paper.
Cotton swabs can be used as long as no cotton fibers remain on the fiber end after cleaning.
- 2 Clean the ferrules and other parts of the connector while avoiding the end of the fiber.
- 3 Apply isopropyl alcohol to a new clean lint-free cotton swab or lens paper.
- 4 Clean the fiber end with the swab or lens paper.
Do *not* scrub during this initial cleaning because grit can be caught in the swab and become a gouging element.
- 5 Immediately dry the fiber end with a clean, dry, lint-free cotton swab or lens paper.
- 6 Blow across the connector end face from a distance of 6 to 8 inches using filtered, dry, compressed air. Aim the compressed air at a shallow angle to the fiber end face.
Nitrogen gas or compressed dust remover can also be used.

CAUTION

Do not shake, tip, or invert compressed air canisters, because this releases particles in the can into the air. Refer to instructions provided on the compressed air canister.

- 7 As soon as the connector is dry, connect or cover it for later use.
If the performance, after the initial cleaning, seems poor try cleaning the connector again. Often a second cleaning will restore proper performance. The second cleaning should be more arduous with a scrubbing action.

To clean an adapter

The fiber-optic input and output connectors on many Agilent Technologies instruments employ a universal adapter such as those shown in the following picture. These adapters allow you to connect the instrument to different types of fiber-optic cables.



Figure 6-8. Universal adapters.

- 1 Apply isopropyl alcohol to a clean foam swab.

Cotton swabs can be used as long as no cotton fibers remain after cleaning. The foam swabs listed in this section's introduction are small enough to fit into adapters.

Although foam swabs can leave filmy deposits, these deposits are very thin, and the risk of other contamination buildup on the inside of adapters greatly outweighs the risk of contamination by foam swabs.

- 2 Clean the adapter with the foam swab.
- 3 Dry the inside of the adapter with a clean, dry, foam swab.
- 4 Blow through the adapter using filtered, dry, compressed air.

Nitrogen gas or compressed dust remover can also be used. Do not shake, tip, or invert compressed air canisters, because this releases particles in the can into the air. Refer to instructions provided on the compressed air canister.

Care of Connector Savers

The connector saver is used to protect the input connector of the OSA from damage. It functions as a standoff between the front panel input connector and the input fiber. If the fibers are not thoroughly cleaned, repeated connections can result in a scratched, chipped, or dirty input connector. Contamination, or damage to the connector, will cause loss of signal and increased reflections resulting in poor return loss and measurement error. With glass-to-glass interfaces, any degradation of a ferrule or fiber endface, any stray particles, or finger oil on the endface can have a significant effect on connector performance. Many times an instrument must be serviced to replace a damaged connector when thousands of dollars and lost time could have been avoided if better care were given to the fiber optic connector.

The connector saver is intended to serve as a replaceable interface. When cleaned and attached to the front panel, it should remain in place and successive input fiber changes should be attached to the connector saver. If the connector saver is damaged, you can easily replace it. Connector saver damage can be detected by examining the connector saver with a fiber scope, a reflectometer, or substituting a new connector saver (and observing a difference in the measurement).

The connector saver should be cleaned before any connection. While the connector saver is provided to protect the front panel input connector from dirty fibers, the fiber and connector saver must be cleaned. Any dirt between fiber connections causes high insertion loss and increased reflections and can also damage the fibers themselves. The advantage to using the connector saver is that if it is damaged, it is much less expensive and faster to replace than the front panel input connector.

Cleaning Connector Savers

The two ends of the connector saver should be cleaned differently. The ferrule fiber end of the connector saver can be cleaned in the same manner as a fiber patch cord, or a cable, using the method described below. The recessed fiber end of the input connector saver presents a different cleaning challenge. Because of the limited access within the recessed end, it is not recommended that alcohol be used in the cleaning process. If not quickly wiped away with another cotton swab, or blown dry with compressed air, alcohol can leave a residue which interferes with measurements. We have found that in the recessed end of the connector saver, it is difficult to prevent this alcohol residue buildup.



To clean the ferrule end of the connector saver

- 1 Apply isopropyl alcohol to a clean cotton swab.

Cotton swabs can be used making sure no cotton fibers remain after cleaning. Although foam swabs can leave filmy deposits, these deposits are very thin. The risk of other contamination buildup on the connection surface greatly outweighs the risk of contamination by foam swabs.

- 2 Clean the adapter with a wet swab.
- 3 Clean the adapter with a clean, dry swab.
- 4 Blow across the adapter using filtered, dry, compressed air.

CAUTION

Do not shake, tip, or invert compressed air canisters. This releases particles from the can into the air flow. Refer to the instructions on the compressed air canister.

Maintenance

Cleaning Connections for Accurate Measurements

To clean the recessed end of the connector saver

- To clean the recessed end of the connector saver, it is recommended that a wrapped tip swab or stick cleaner be used. Berkshire's LT670183 wrapped tip cotton swab, or Cletop stick cleaners have proven to be an effective cleaning solution. To clean the recessed end of the connector saver, insert the stick type cleaner, and rotate it several times the same direction. Each swab should only be used once. While this may not remove all of the contaminants, it will displace them away from the center of the fiber (away from the core).



Returning the Instrument for Service

Agilent Technologies aims to maximize the value you receive, while minimizing your risk and problems. We strive to ensure that you get the test and measurement capabilities you paid for and obtain the support you need. Our extensive support resources and services can help you choose the right Agilent products for your applications and apply them successfully. Every instrument and system we sell has a global warranty. Support is normally available for at least five years beyond the production life of the product. Two concepts underlie Agilent's overall support policy: "Our Promise" and "Your Advantage".

Our Promise means your Agilent test and measurement equipment will meet its advertised performance and functionality. When you are choosing new equipment, we will help you with product information, including realistic performance specifications and practical recommendations from experienced test engineers. When you use Agilent equipment, we can verify that it works properly, help with product operation, and provide basic measurement assistance for the use of specified capabilities, at no extra cost upon request. Often, many self-help tools are available.

Your Advantage means that Agilent offers a wide range of additional expert test and measurement services, which you can purchase according to your unique technical business needs. Solve problems efficiently and gain a competitive edge by contracting with us for calibration, extra-cost upgrades, out-of-warranty repairs, and on-site education and training, as well as design, system integration, project management, and other professional engineering services. Experienced Agilent engineers and technicians worldwide can help you maximize your productivity, optimize the return on investment of your Agilent instruments and systems, and obtain dependable measurement accuracy for the life of those products.

By internet, phone, or fax, get assistance with your test and measurement needs.

Online assistance: www.agilent.com/find/assist

United States

(tel) 1 800 452 4844

Latin America

(tel) (305) 269 7500

(fax) (305) 269 7599

Maintenance
Returning the Instrument for Service

Canada

(tel) 1 877 894 4414

(fax) (905) 206 4120

Australia

(tel) 1 800 629 485

(fax) (61 3) 9210 5947

Europe

(tel) (31 20) 547 2323

(fax) (31 20) 547 2390

New Zealand

(tel) 0 800 738 378

(fax) 64 4 495 8950

Japan

(tel) (81) 426 56 7832

(fax) (81) 426 56 7840

Asia Pacific

(tel) (852) 3197 7777

(fax) (852) 2506 9284

Preparing the instrument for shipping

- 1 Write a complete description of the failure and attach it to the instrument. Include any specific performance details related to the problem. The following information should be returned with the instrument.
 - Type of service required.
 - Date instrument was returned for repair.
 - Description of the problem:
 - Whether problem is constant or intermittent.
 - Whether instrument is temperature-sensitive.
 - Whether instrument is vibration-sensitive.
 - Instrument settings required to reproduce the problem.
 - Performance data.
 - Company name and return address.
 - Name and phone number of technical contact person.
 - Model number of returned instrument.
 - Full serial number of returned instrument.
 - List of any accessories returned with instrument.
- 2 Cover all front or rear-panel connectors that were originally covered when you first received the instrument.

CAUTION

Cover electrical connectors to protect sensitive components from electrostatic damage. Cover optical connectors to protect them from damage due to physical contact or dust.

CAUTION

Instrument damage can result from using packaging materials other than the original materials. Never use styrene pellets as packaging material. They do not adequately cushion the instrument or prevent it from shifting in the carton. They may also cause instrument damage by generating static electricity.

- 3 Pack the instrument in the original shipping containers. Original materials are available through any Agilent Technologies office. Or, use the following guidelines:
 - Wrap the instrument in antistatic plastic to reduce the possibility of damage caused by electrostatic discharge.
 - For instruments weighing less than 54 kg (120 lb), use a double-walled, corrugated cardboard carton of 159 kg (350 lb) test strength.
 - The carton must be large enough to allow approximately 7 cm (3 inches) on all sides of the instrument for packing material, and strong enough to accommodate the weight of the instru-

Maintenance

Returning the Instrument for Service

ment.

- Surround the equipment with approximately 7 cm (3 inches) of packing material, to protect the instrument and prevent it from moving in the carton. If packing foam is not available, the best alternative is S.D-240 Air Cap™ from Sealed Air Corporation (Commerce, California 90001). Air Cap looks like a plastic sheet filled with air bubbles. Use the pink (antistatic) Air Cap™ to reduce static electricity. Wrapping the instrument several times in this material will protect the instrument and prevent it from moving in the carton.
- 4 Seal the carton with strong nylon adhesive tape.
 - 5 Mark the carton "FRAGILE, HANDLE WITH CARE".
 - 6 Retain copies of all shipping papers.

Definition of Terms 7-3
Specifications 7-5
 Additional Specifications—Agilent 86146B 7-9
 General Instrument Specifications 7-9
 Option 001 Current Source 7-11
 Option 002 White Light Source 7-11
 Option 004 EELED Sources 7-12
Regulatory Information 7-14
Declaration of Conformity 7-15

Specifications and Regulatory Information

This chapter contains specifications and characteristics for Agilent 8614xB optical spectrum analyzers (OSA).

- The specifications in this chapter apply to all functions autocoupled over the temperature range 0°C to +55°C and relative humidity < 95% (unless otherwise noted).
- All specifications apply after the instrument's temperature has been stabilized after 1 hour continuous operation and the auto-align routine has been run.
- Unless otherwise noted, specifications apply without USER CAL.
- All specifications apply to measurements made *without* using the front-panel connector saver.

Calibration Cycle

This instrument requires periodic verification of performance. The instrument should have a complete verification of specifications at least once every two years.

Definition of Terms

Characteristics and specifications

The distinction between specifications and *characteristics* is described as follows:

Specifications describe warranted performance.

Characteristics provide useful, but nonwarranted information about the functions and performance of the instrument. *Characteristics are printed in italics.*

Wavelength

Absolute Accuracy (after user cal) refers to the wavelength accuracy after the user has performed the internal wavelength calibration using a source of known wavelength.

Tuning Repeatability refers to the wavelength accuracy of returning to a wavelength after having tuned to a different wavelength.

Reproducibility refers to the amount of wavelength drift which can occur over the specified time while the optical spectrum analyzer is swept across a source of known wavelength.

Resolution

FWHM refers to the Full-Width-Half-Maximum resolutions that are available. This indicates the width at the half power level of the signal after passing through the resolution slits.

Specifications and Regulatory Information

Definition of Terms

Amplitude	<p><i>Scale Fidelity</i> refers to the potential errors in amplitude readout at amplitudes other than at the calibration point. This specification is sometimes called linearity.</p> <p><i>Flatness</i> defines a floating band which describes the error in signal amplitude over the indicated wavelength range. (This error may be removed at a given wavelength by performing the user amplitude calibration.)</p> <p><i>Polarization Dependence</i> refers to the amplitude change that can be seen by varying the polarization of the light entering the OSA. This is not to be confused with amplitude variations caused by the varying distribution of energy between the different modes in fiber that is multimode at the wavelength of interest.</p>
Sensitivity	<p><i>Sensitivity</i> is defined as the signal level that is equal to six times the RMS value of the noise. Displayed sensitivity values are nominal. Slightly lower values may have to be entered to achieve specified sensitivity.</p>
Dynamic range	<p><i>Dynamic Range</i> is a measure of the ability to see low-level signals that are located very close (in wavelength) to a stronger signal. In electrical spectrum analyzers, this characteristic is generally called shape factor.</p>
Sweep time	<p><i>Maximum Sweep Rate</i> refers to the maximum rate that the instrument is able to acquire data and display it. This rate may be limited by multiple internal processes when using default number of trace points.</p> <p><i>Sweep Cycle Time</i> refers to the time required to make a complete sweep and prepare for the next sweep. It can be measured as the time from the start of one sweep to the start of the next sweep.</p>

Specifications

NOTE The 86146B specifications are for the 50 μm internal path only.

Table 7-1. Wavelength Specifications

Wavelength Range	600 nm to 1700 nm
Reproducibility ≤1 min ^a	±0.002 nm
Span Range	0.2 nm to full range and zero span
Accuracy	
After calibration with internal calibration source and with enhanced wavelength calibration on for specified range ^{a,b,c}	
1480 to 1570 nm	±0.01 nm
1570 to 1620 nm	±0.025 nm
After calibration with external reference source(s) ±10 nm of calibration reference point(s) ^{a, b, c}	±0.01 nm
After user calibration over full wavelength range ^{a, d} 600 nm - 1700 nm	±0.2 nm
Absolute Accuracy ^{a,d,e}	±0.5 nm
Tuning Repeatability (≤1 min) ^a	±0.002 nm
Span Linearity ^{a,b,d}	
1525 nm - 1570 nm	±0.01 nm
for spans <40 nm	±0.02 nm

- a. With applied input fiber 9/125μm
- b. Typical
- c. At room temperature
- d. Temperature range 20 to 30°C
- e. Factory calibration on a 2-year cycle

Table 7-2. Resolution Bandwidth (RBW) Specifications

Resolution Bandwidth (RBW)	Agilent 86142B, 86143B, 86145B	Agilent 86146B ^a	Agilent 86143B w/Opt 025
FWHM (3 dB Bandwidth) ^{b,c}	0.06, 0.1, 0.2, 0.5, 1, 2, 5, 10 nm	0.06, 0.07, 0.1, 0.14, 0.2, 0.33, 0.5, 1, 2, 5, 10 nm	0.07, 0.1, 0.2, 0.5, 1, 2, 5, 10 nm

Specifications and Regulatory Information
Specifications

Noise Marker Bandwidth Accuracy using noise markers 1525-1610 nm ^{a,d}			
≥0.5 nm	±2%	2%	±3%
0.2 nm	±3%	±3%	±5%
0.1 nm	±7%	±7%	±10%
0.06 nm	±12%	±12%	-----

- a. The 86146B specifications are for the 50 μm internal path only.
- b. With applied input fiber 9/125 μm
- c. Resolution of 10 nm is available for first order grating response only
- d. Temperature range 20 to 30°C

Table 7-3. Amplitude Specifications

Amplitude	Agilent 8614xB ^a
Sensitivity ^b	
600-750 nm ^{c,d}	-60 dBm
750-900 nm ^{c,d}	-75 dBm
900-1250 nm ^c	-75 dBm
1250-1610 nm ^c	-90 dBm
1610-1700 nm ^e	-80 dBm
Maximum Measurement Power ^{f,g}	
1525-1700 nm	<i>+15 dBm per channel, +30 dBm total</i>
600-1000 nm	<i>+15 dBm per channel, +30 dBm total</i>
1000-1525 nm	<i>+12 dBm per channel, +30 dBm total</i>
Maximum Safe Power	
Total safe power	+30 dBm
Total power within any 10 nm portion of the spectrum	+23 dBm
Absolute Accuracy ^{h, k}	
at -20 dBm, 1310 nm/1550 nm	±0.5 dB
Scale Fidelity ^{e,i, k}	
Autorange off	± 0.05 dB
Autorange on	± 0.07 dB
Display Scale (log scale)	0.01-20 dB/DIV. -120 to +90 dBm
Amplitude Stability ^k	
(1310 nm, 1550 nm)	
1 minute ^j	±0.01 dB
15 minutes ^g	±0.02 dB

Amplitude	Agilent 8614xB ^a		
	Agilent 86143B	Agilent 86142B, 86145B, 86146B	Agilent 86143B w/Opt 025
Flatness ^k			
1290-1330 nm	----	±0.2 dB	----
1525-1570 nm	±0.2 dB	----	±0.2 dB
1525-1610 nm	----	±0.2 dB	----
1250-1610 nm ^l	----	±0.7 dB	----
Polarization Dependence ^{k,m,n}			
1310 nm	± 0.25 dB	± 0.12 dB	----
1530 nm, 1565 nm	± 0.2 dB	± 0.05 dB	----
1600 nm	± 0.25 dB	± 0.08 dB	----
1250 to 1650 nm	± 0.3 dB	± 0.25 dB	± 0.5 dB

- a. The 86146B specifications are for the 50 µm internal path only.
- b. Sensitivity is defined as signal value >6 X RMS noise value
- c. Temperature range 0 to 30° C
- d. Second Order
- e. Temperature range 20 to 30° C
- f. Resolution bandwidth setting <channel spacing
- g. Typical
- h. For resolution ≥0.1 nm
- i. Excluding amplitude errors at low power levels due to noise
- j. For signals within 8 dB of top of screen
- k. With applied input fiber 9/125 µm
- l. Absorption of light by atmospheric moisture affects flatness at 1350-1420 nm
- m. For resolution ≥0.2 nm
- n. Room temperature

Table 7-4. Dynamic Range Specifications

	Agilent 86143B	Agilent 86142B, 86145B, 86146B ^a	Agilent 86143B w/Opt 025
In 0.1 nm resolution bandwidth ^{b,c}			
1250 to 1610 nm (chop mode on) ±0.5 nm, ±1 nm, ±5 nm ^{d,e}	-70 dB	-70 dB	-70 dB
1550 nm at ±0.8 nm (±100 GHz at 1550 nm) ^f	-60 dB	-60 dB	-60 dB
1550 nm at ±0.5 nm ^g (±62.5 GHz at 1550 nm)	-58 dB	-58 dB	-55 dB
1550 nm at ±0.4 nm ^g (±50 GHz at 1550 nm)	-55 dB	-55 dB	-52 dB
1550 nm at ±0.2 nm ^d (±25 GHz at 1550 nm)	-40 dB	-40 dB	----

Specifications and Regulatory Information
Specifications

- a. The 86146B specifications are for the 50 μm internal path only.
- b. Excluding multiple order grating response
- c. With applied input fiber 9/125 μm
- d. Typical
- e. Chop mode not available on the 86146B models
- f. Average of all states of polarization
- g. Typical for 86143B, 86143B with option 025

Table 7-5. Monochromator Input Specifications

Monochromator Input	Agilent 8614xB ^a		
Input Return Loss ^{b,c}	>35 dB	>35 dB	>35 dB

- a. The 86146B specifications are for the 50 μm internal path only.
- b. Depends on the quality of the attached connector
- c. With a 9/125 μm straight connector

Table 7-6. Sweep Specifications

Sweep	Agilent 8614xB ^a
Maximum Sweep Rate ^b	40 nm/56.3 ms
Maximum Sampling Rate in Zero Span ^b	50 ms/trace point
Sweep Cycle Time ^b	
50 nm span, auto zero off	<180 ms
50 nm span, auto zero on	<340 ms
100 nm span	<400 ms
500 nm span	<650 ms
ADC Trigger Accuracy ^b	
Jitter (distributed uniformly)	< ± 0.5 ms
Trigger delay range	2 ms-6.5 ms

- a. The 86146B specifications are for the 50 μm internal path only.
- b. Typical

Table 7-7. Pulse Mode Accuracy Specifications

PULSE MODE ACCURACY	Agilent 86143B	Agilent 86142B, 86145B, 86146B ^a	Agilent 86143B w/Opt 025
Turn On (≥ 2 ms after rising edge) ^{a,b}	< ± 0.2 dB	< ± 0.2 dB	< ± 0.2 dB
Turn Off (≥ 10 ms after falling edge) ^c	< ± 0.2 dB	< ± 0.2 dB (30 dB extinction)	< ± 0.2 dB

- a. Typical
- b. Starting from dark
- c. Typical for 86143B, 86146B, 86143B w/Opt 025

Table 7-8. General Instrument Specifications

	Agilent 86142B, 86146B Benchtop	Agilent 86143B, 86145B Portable
Dimensions	222 mm H × 425 mm W × 427 mm D (8.8 in × 16.8 in × 16.8 in)	163 mm H × 325 mm W × 427 mm D (6.4 in × 12.8 in × 16.8 in)
Weight	16.5 kg (36 lb)	14.5 kg (31 lb)
Environmental	Operating: 0°C to 55°C; Storage: –40°C to 70°C Humidity Operating: < 95% RH; Storage: Non-condensing Altitude Up to 2,000 meters (6,600 feet)	
Power Requirements	Voltage and Frequency 100 / 115 / 230/ 240 V~, 50 / 60 Hz Maximum Power Consumption 250 W	
Computer Interfacing	Remote Control Web enabled controls Compatibility IEEE-488.1, IEEE-488.2 (100%) Interfaces GPIB, Parallel Printer Port, External VGA Monitor, Keyboard and Mouse (PS/2) Floppy Disk 3.5 inch 1.44 MB, MS-DOS® Data Export Spreadsheet and Word Processor Compatible (CSV ASCII) Graphics Export CGM, PCL, GIF Instrument Drivers Universal Instrument Drivers (PNP), Compatible with Agilent VEE, Labview®, Visual Basic and C++	

a. Floppy disk and printer operating temperature range 0 °C to 45 °C.

Agilent 86146B Additional Specifications

WARNING

The light emitted from the MONOCHROMATOR OUTPUT connector is filtered and slightly attenuated light input to the front-panel MONOCHROMATOR INPUT connector. Light can radiate from the front panel in the following instrument modes: filter mode, external path, and stimulus response.

NOTE

The following 86146B specifications are for the 9 µm filter mode only.

Table 7-9. Additional Specifications—Agilent 86146B

	Agilent 86146B
Insertion Loss Stability ^a 1550 nm, 15 minutes	0.5 dB
Insertion Loss ^b 1550 nm	typ. 10 dB ^c

- a. Immediately following enhanced single point auto align, at constant temperature.
- b. For room temperature only. For room temperature only.
- c. For serial numbers DE44103007 and higher. 10 dB max. insertion loss otherwise.

Table 7-10. Additional Specifications—Agilent 86146B

	Agilent 86146B		
Filter Bandwidth ^{a, b}	0.5 dB	1.0 dB	3.0 dB
RBW Nominal Setting	Actual Bandwidth		
0.04 nm	0.016	0.023	0.039
0.05 nm	0.019	0.026	0.045
0.07 nm	0.033	0.044	0.063
0.1 nm	0.076	0.089	0.115
0.2 nm	0.134	0.147	0.173
0.3 nm	0.257	0.270	0.297
0.5 nm	0.421	0.434	0.460
	±20%		

- a. From 1530-1610 nm
- b. Typical

Table 7-11. Filter Bandwidth

Adjacent Channel Rejection (at 1550nm) ^{a, b}	Agilent 86146B			
	12.5 GHz	25 GHz	50 GHz	100 GHz
	±0.1 nm	±0.2 nm	±0.4 nm	±0.8 nm
0.04 nm	40 dB	50 dB	55 dB	55 dB
0.05 nm	40 dB	50 dB	55 dB	55 dB
0.07 nm	----	50 dB	55 dB	55 dB
0.1 nm	----	40 dB	50 dB	55 dB
0.2 nm	----	40 dB	45 dB	55 dB
0.3 nm	----	----	45 dB	55 dB
0.5 nm	----	----	45 dB	50 dB

a. Typical

b. Adjacent Channel Rejection Limited to 60dB below total integrated power

Table 7-12. Option 001 Current Source

Current Output	Agilent 86142B, 86146B Only
Range	0 to ±200 mA (source or sink)
Resolution ^a	50 mA steps
Accuracy	2% ±50 mA
Clamp Voltage ^b	±2.7V
Noise Density at 1 kHz ^a	<4 nA/√Hz
Stability Within 30 Minutes ^a	<100 ppm ±500 nA
Temperature Drift ^a	<(100 ppm ±500 nA)/K
Pulse Mode	
Pulse Range	10 μs to 6.5 ms
Pulse Resolution	100 ns
Duty Cycle Range	Pulse width/1 s to 100%

a. Typical

b. Nominal

Table 7-13. Option 002 White Light Source

	Agilent 86142B, 86146B only
Wavelength ^a	900 nm to 1700 nm
Minimum Output Power Spectral Density ^b	
900 to 1600 nm	-67 dBm/nm (0.2 nW/nm)
900 to 1600 nm (typical)	-64 dBm/nm (0.4 nW/nm)
1600 to 1700 nm	-70 dBm/nm (0.1 nW/nm)

Specifications and Regulatory Information
Specifications

	Agilent 86142B, 86146B only
Minimum Output Power Spectral Density ^{c, d} 50/125 μm fiber 62.5/125 μm fiber	<i>-50 dBm/nm (10 nW/nm)</i> <i>-46 dBm/nm (25 nW/nm)</i>
Output Stability ^b	± 0.02 dB over 10 minutes
Lamp Lifetime, Mean Time Between Failures	<i>>5000 hours</i>

- a. Filtered below 850 nm.
- b. With applied input fiber 9/125 μm .
- c. Typical
- d. Includes power in full numerical aperture of fiber.

Table 7-14. Option 004 EELED Sources

	Agilent 86142B, 86146B only
Minimum Spectral Power Density 1300 to 1320 nm, 1540 to 1560 nm - option 004 1250 to 1620 nm - option 004 ^a	<i>> -40 dBm/nm (100 nW/nm)</i> <i>> -60 dBm/nm (1 nW/nm)</i>
Return Loss ^a With straight connector	<i>>25 dB</i>
Stability (ambient temp $<\pm 1^\circ\text{C}$) ^a Over 15 minutes Over 6 hours	<i>$<\pm 0.02$ dB</i> <i>$<\pm 0.05$ dB</i>

- a. Typical

Option 006 Wavelength Calibrator

The wavelength calibrator option provides an onboard wavelength reference that can be used to automatically calibrate the optical spectrum analyzer. The calibrator is based on an EELED and an Acetylene gas absorption cell.

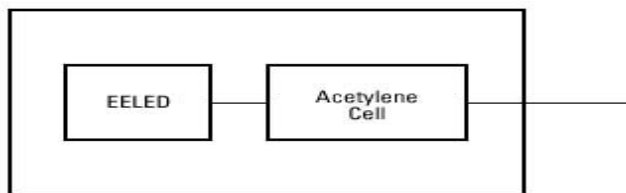

Wavelength Calibrator Block Diagram

The acetylene absorbs light at very specific wavelengths based on the molecular properties of gas. The cell is illuminated by an EELED and the OSA uses the absorption pits to perform a wavelength calibration. Since the absorption of the acetylene gas is a physical constant, it never needs calibrating.

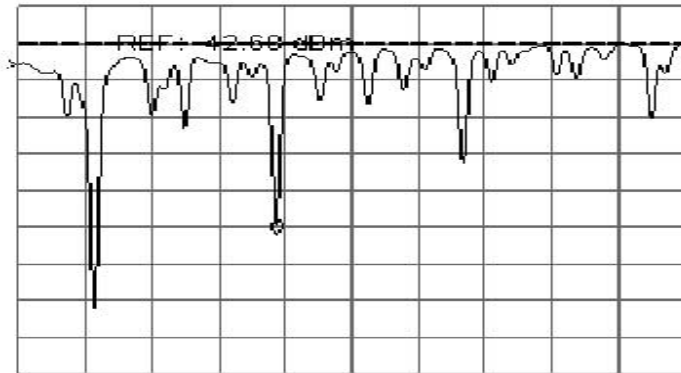

Wavelength calibrator absorption spectrum

The wavelength calibrator enhances the OSA to achieve better than ± 10 pm wavelength accuracy and removes the need to use a tunable laser source and multi-wavelength meter as an external reference.

Table 7-15. Additional Parts and Accessories

	Agilent Benchtop OSA 86142B, 86146B	Agilent Portable OSA 86143B, 86145B
Printer Paper (5 rolls/box)	9270-1370	9270-1370
Additional Connector Interfaces	See Agilent 81000 series	See Agilent 81000 series
External 10 dB Attenuator (FC/PC)	Opt. 030	Opt. 030
9 mm Single Mode Connector Saver	Standard	Standard
Rack-Mount Flange Kit	Opt. AX4	N/A
Transit Case	9211-2657	9211-5604
Soft Carrying Case	N/A	Opt. 042
BenchLink Lightwave Software ^a	Standard	Standard

a. Agilent N1031A BenchLink Lightwave allows transfer of measurement results over a GPIB Interface to a PC for the purposes of archiving, printing, and further analysis.

Regulatory Information

- Compliance with Canadian EMC Requirements

This ISM device complies with Canadian ICES-001.
Cet Appareil ISM est conforme a la norme NMB du Canada.

Notice for Germany: Noise Declaration

Acoustic Noise Emission	Geraeuschemission
LpA < 70 dB	LpA < 70 dB
Operator position	am Arbeitsplatz
Normal position	normaler Betrieb
per ISO 7779	nach DIN 45635 -1

Declaration of Conformity



Manufacturer's Name: Agilent Technologies Manufacturing GmbH & Co. KG
Manufacturer's Address: Photonic Measurement Division (PMD)
Herrenberger Str. 130
D-71034 Boeblingen

Declares under sole responsibility that the product as originally delivered

Product Name: Optical Spectrum Analyzer
Product Numbers: 86140B, 86142B, 86143B, 86145B, 86146B
Product Options: This declaration covers all options of the above products.

complies with the essential requirements of the following applicable European Directives, and carries the CE marking accordingly:

- The Low Voltage Directive 73/23/EEC, amended by 93/68/EEC
- The EMC Directive 89/336/EEC, amended by 93/68/EEC

and conforms with the following product standards:

	Standard	Limit
EMC	IEC 61326:1997+A1/1998 / EN 61326:1997+A1/1998	
	CISPR 11:1997 / EN 55011:1998	Group 1 Class A
	IEC 61000-4-2:2001 / EN 61000-4-2:2001	4 kV CD, 8 kV AD
	IEC 61000-4-3:2001 / EN 61000-4-3:2001	3 V/m, 80-1000 MHz
	IEC 61000-4-4:1995+A1:2000+A2:2001 / EN 61000-4-4:2002	0.5 kV signal lines, 1 kV power lines
	IEC 61000-4-5:2001 / EN 61000-4-5:2001	0.5 kV line-line, 1 kV line-ground
	IEC 61000-4-6:2001 / EN 61000-4-6:2001	3 V, 0.15-80 MHz
	IEC 61000-4-8:2001 / EN 61000-4-8:2001	30 A/m
	IEC 61000-4-11:2001 / EN 61000-4-11:2001	1 cycle/100%
	Canada: ICES-001:1998	
	Australia/New Zealand: AS/NZS 2064.1	
	Safety	IEC 61010-1:2001 / EN 61010-1:2001
Canada: CSA C22.2 No. 1010.1:1992		
USA: UL 3111-1:1994		

Supplemental Information:

The products were tested in a typical configuration with Agilent Technologies test systems.

2004-March-11
Date

Hans-Martin Fischer
Name
Product Regulations Representative
Title

For further information, please contact your local Agilent Technologies sales office, agent or distributor.
Authorized EU-representative: Agilent Technologies Deutschland GmbH, Herrenberger Strasse 130, D-71034 Boeblingen, Germany

A

- absolute accuracy, 7-3
- accessories
 - product, 1-8
 - static-safe, 6-4
- accuracy
 - absolute/differential, 7-3
- active
 - function area assist, 3-22
- Active Function Area Assist, 3-2
- active function area, moving, 2-11, 3-41
- Active Marker softkey, 3-3
- Active Marker... softkey, 3-52
- Active Trace softkey, 3-3
- adapters, 1-8
- Agilent logo, 3-4
- Agilent logo, displaying, 3-22
- alignment
 - automatic, 1-13
- AMPCOR, 3-8
- amplitude
 - accuracy, increasing, 3-12
 - correction, 3-8
 - sensitivity, 3-74
 - units, setting, 3-6
- Amplitude functions
 - AMPCOR, 3-8
- Amplitude menu, 1-17
- amplitude setup panel
 - auto range, 3-12
 - auto zero, 3-12
 - reference level position, 3-64
 - units, 3-8
- Applications functions
 - filter mode, 3-78
 - measurement mode, 3-40
 - power meter mode, 3-56
 - power meter zero, 3-56
- Applications menu, 1-15
- auto
 - chop mode, setting, 3-7
 - ranging, setting, 3-7
 - zero, setting, 3-7
- Auto Align key, 1-13
- Auto Meas key, 1-13
- auto ranging, 3-12
- auto zero

- function, 3-96
- setting, 3-12

- automatic
 - alignment, 1-13
- Averaging softkey, 3-13

B

- Backup Internal Memory softkey, 2-19, 3-13
- Backup/Restore Menu softkey, 3-14
- bandwidth
 - markers, 3-33
- bandwidth marker, 1-14
 - interpolation, setting, 3-36
 - units, setting, 3-36
- Bandwidth/Sweep menu, 1-20

C

- calibrating the instrument, 3-53
- calibration
 - cycle, 7-2
 - date, 3-91
 - date, viewing, 3-7
 - power, 3-7
- care of fiber optics, 1-iv, 1-11
- Center Wavelength softkey, 3-17
- CGM, graphic saving, 2-21
- characteristics, 7-2
- Choose Files to Save softkey, 2-21
- cleaning
 - adapters, 6-17
 - fiber-optic connections, 6-8, 6-16
 - non-lensed connectors, 6-16
 - printer head, 6-4
- Configure Network softkey, 3-18
- connecting
 - printer, 1-10
- connector care, 6-8
- continuous sweep, 3-65
- cotton swabs, 6-15
- cycle time, sweep, 7-4

D

- date
 - displaying, 3-22
 - wavelength calibration, 3-93

Index

- date, setting, 3-75
 - dB per division, 3-72
 - declaration of conformity, 7-20
 - default instrument settings, 3-59
 - Default Math softkeys, 3-19
 - Delete Menu softkey, 3-20
 - delta between traces, 2-27
 - delta marker, 1-14
 - units, setting, 3-36
 - Delta Marker softkey, 3-20
 - display
 - adding a title, 2-18
 - Agilent logo, 3-22
 - date/time, 3-22
 - overview, 1-6
 - printing, 1-14
 - scaling, 3-72
 - title, 3-22
 - display setup panel
 - Agilent logo, 3-4
 - time/date, 3-19, 3-84
 - title, 3-85
 - Display Setup softkey, 3-21
 - documentation, part numbers, 1-29
 - Domain Name, 3-89
 - dust caps, 6-16
 - dynamic range, 7-4
- E**
- Electrostatic (ESD) information, 6-4
 - Exchange Menu softkey, 3-23
 - Extended State Information softkey, 3-49
 - external printer, 3-60
- F**
- factory
 - wavelength calibration date, 3-93
 - Factory Preset softkey, 3-23
 - Fast Meas Save softkey, 3-24
 - fast save, 2-19
 - FDA laser safety, 1-27
 - fiber optics
 - care of, 1-iv, 1-11
 - cleaning connections, 6-8
 - connectors, covering, 6-23
 - File menu, 1-15
 - File Share, 3-28
 - File Shares softkey, 3-25
 - File Sharing, 3-89
 - filename
 - entering, 2-21
 - saving, 2-21, 3-70
 - filter mode, 3-78
 - firmware revision, 3-67
 - Firmware Upgrade softkey, 3-27
 - flatness, 7-4
 - floppy disk
 - recalling data, 2-24
 - saving data, 2-21, 3-71
 - foam swabs, 6-15
 - front panel
 - descriptions, 1-4
 - tutorial, 1-12
 - function area assist, 3-22
 - function reference, 3-2
 - FWHM resolution, 7-3
- G**
- gateway address, 4-2
 - GIF, 3-71
 - GIF, graphic saving, 2-21
 - GPIB & Network Setup, 3-28
 - GPIB address, 3-18
 - graphics data, saving, 2-21, 3-70
- H**
- hardware errors, viewing, 3-28
 - Help softkey, viewing error messages, 3-28
 - hi gain trans Z, 3-49
 - Hold Trace softkey, 3-29
- I**
- INPUT connector, 1-iv, 1-11
 - input connector, 6-8
 - instrument
 - address, 3-42
 - checking the shipment, 1-8
 - state, 3-50
 - internal memory, 2-24
 - backup/restore, 2-19
 - saving data, 2-21, 3-71

internal printer, 3-60
 internet protocol, 4-2
 interpolation, normal/delta marker, 3-36
 IP address, 4-2

L

laser
 classifications, 1-27
 safety, 1-27
 Lin Math softkeys, 3-30, 3-31
 line markers, 3-94
 Line Markers Off softkey, 3-30
 lo gain trans Z, 3-49
 Local key, 3-31
 Log Math softkeys, 3-31, 3-32

M

manual, part numbers, 1-29
 map display window, 4-12, 4-15
 marker
 search threshold, setting, 3-38
 types, 1-14
 Marker BW softkey, 3-33
 Marker menu, 1-21
 Marker Off softkey, 3-33
 Marker Search Menu softkey, 3-34
 marker setup panel
 bandwidth marker interpolation, 3-15
 BW marker units, 3-15
 delta marker units, 3-21
 marker search threshold, 3-89
 marker search threshold value, 3-34
 normal marker units, 3-45
 normal/delta marker interpolation, 3-44
 peak excursion, 3-51
 peak search at end of each sweep, 3-53
 pit excursion, 3-54
 Marker to Center softkey, 3-39
 Marker to Ref Level softkey, 3-39
 markers
 active marker, 3-3
 All Off softkey, 3-5
 line markers, 3-94
 marker BW, 3-33
 marker off, 3-33
 marker to center, 3-39

marker to reference level, 3-39
 moving between traces, 2-27
 peak search, 3-52
 peak to center, 3-51
 search limit, 3-73
 tips for using, 2-26
 Markers key, 3-39
 maximum
 sweep rate, 7-4
 Measure menu, 1-15
 measurement
 fast save, 2-19
 recalling data, 2-23
 recalling data in Fast Save mode, 2-23
 saving data, 2-20
 measurement modes
 power meter, 3-56
 Measurement Modes softkey, 3-40
 measuring
 delta between traces, 2-27
 passband, 3-33
 using markers, 2-26
 menu
 bar, 1-15
 Move Power Display Area softkey, 3-41

N

net mask, 4-2
 Network File Share, 3-28, 3-70
 network printers, 3-61
 network setup, 3-25
 Next Peak Down softkey, 3-52
 Next Peak Left softkey, 3-52
 Next Peak Right softkey, 3-52
 Next Peak softkeys, 3-42, 3-43
 Next Pit softkeys, 3-43, 3-44
 noise
 declaration, 7-19
 marker reference bandwidth, setting, 3-38
 markers, 1-14
 non-normalized amplitude scale, 3-3
 normal marker, 1-14
 units, setting, 3-36
 normal/delta marker interpolation, 3-36
 normalized
 display scale, 3-3
 number of points, sweep, 3-81

Index

O

operating system revision, 3-67
optimize sensitivity, 3-11
Options menu, 1-15

P

package contents, 1-8
packaging for shipment, 6-24
panels, setup, 2-3
part numbers, 1-29
Peak Excursion softkey, 3-51
peak excursion, setting, 3-37
peak search, 3-73
 end of each sweep, setting, 3-38
 performing, 1-13
Peak Search softkey, 3-52
Peak to Center softkey, 3-51
Peak to Ref Level softkey, 3-53
Perform Calibration softkey, 3-53
pit excursion, 3-54
pit excursion, setting, 3-37
pit search, 3-73
Pit Search softkey, 3-54
polarization dependence, 7-4
power calibration
 date, 3-7
 setting, 3-7
Power Display softkey, 3-55
power meter
 display, 3-55
 display area, moving, 3-41
 units, 3-57
Power Meter Mode softkey, 3-56
Power Meter Zero softkey, 3-56
Preset key, 3-11, 3-59
Print key, 1-14, 3-60
printer
 changing the paper, 6-2
 connecting, 1-10
 head cleaning, 6-4
Printer Setup softkey, 3-60
Printer Shares softkey, 3-61
printing
 display, 1-14
 over network, 3-61
printing, external or internal, 3-60

product information, 1-11
Pwr Mtr Units softkey, 3-57

R

rear panel
 descriptions, 1-4
recall data, 2-23
Recall Menu softkey, 3-63
recall setup panel
 measurement/trace data, 3-61
 recall from, 3-62
REF annotation, 3-63
reference level, 3-6
reference level position, 3-64
Reference Level softkey, 3-63
reflection X, 4-7
regulatory information, 7-19
remote
 setup panel, GPIB address, 3-18
Remote File Sharing, 3-28, 3-70, 3-89
remote front panel, 4-2
remote setup panel, GPIB address, 3-42
Repeat Sweep softkey, 3-65
repeatability, tuning, 7-3
reproducibility, 7-3
Reset Min/Max Hold softkey, 3-67
resets, 2-3
resolution
 FWHM, 7-3
restore internal memory, 2-19
Restore Internal Memory softkey, 2-19, 3-67
returning for service, 6-21
Revision softkey, 3-67

S

safety information, 1-iv
Save menu softkey, 3-69
save setup panel
 measurement/trace save, 3-67
 save to, 3-72
 save traces, 3-72
save, fast mode, 3-24
save/recall functions
 fast recall, 2-23
 fast save, 2-19
 internal memory backup/restore, 2-19

- recalling data, 2-23
- saving data, 2-20
- Save/Recall key, 3-71
- Save/Recall menu, 1-22
- saves, 2-3
- scale fidelity, 7-4
- Scale/Div softkey, 3-72
- screen, 2-19
- search Limit softkey, 3-73
- Search Mode softkey, 3-73
- selecting a measurement mode, 3-40
- selects, 2-3
- sensitivity, 7-4
 - optimizing, 2-8, 3-11
- Sensitivity softkey, 3-74
- service
 - returning for, 6-21
- Set Time/Date softkey, 3-75
- Set Title softkey, title, displaying, 3-75
- Setup panel overview, 2-3
- sharing files, 3-25
- shipment, checking package content, 1-8
- shipping procedure, 6-23
- Show Errors softkeys, 3-76, 3-77
- Show Notices softkey, 3-77
- Show Warnings softkey, 3-78
- signal source, setting, 3-94
- single mode
 - alignment, 3-78
- Single Sweep softkey, 3-79
- softkey panels, 1-16–1-26
- source, single, 3-94
- Span softkey, zero span, 3-79
- specifications, 7-2
- Standard Product, Options, and Accessories, 1-28
- Start WL softkey, 3-80
- State softkey, 3-50
- static-safe
 - accessories, 6-4
- Stop WL softkey, 3-80
- subnetwork mask, 4-2
- swabs, 6-15
- sweep
 - continuous, 3-65
 - cycle time, 7-4
 - rate, maximum, 7-4
- Sweep Key, 3-15
- Sweep Points softkey, 3-81

- system functions
 - active area, moving, 2-11
 - adding a title, 2-18
- System key, 3-84
- System menu, 1-23

T

- time
 - displaying, 3-22
 - setting, 3-75
- time/date, displaying, 3-19, 3-84
- title, creating, 2-18
- title, displaying, 3-85
- trace
 - resolution, 3-81
 - save data, 3-71
- trace math
 - exchange menu, 3-23
 - linear, 3-30, 3-31
 - logarithmic, 3-31, 3-32
 - measuring wl drift, 2-28
- Trace Math Off softkeys, 3-85, 3-86
- Trace Offset softkey, 3-87
- traces
 - Hold softkey, 3-29
 - offset, 3-87
 - recall data, 2-23
 - reset hold, 3-67
 - save data, 2-20
 - update, 3-88
 - view, 3-92
- Traces key, 3-87
- Traces menu, 1-25
- transimpedance amplifier, 2-8, 3-49, 3-96
- TransZ 2-3 Lock softkey, 3-88
- tuning repeatability, 7-3
- tutorial, getting started, 1-12

U

- Update On/Off softkey, 3-88
- update trace, 3-88
- upgrading the firmware, 3-27
- user
 - power cal date, 3-7
 - wavelength calibration date, 3-94
- User Share, 3-28

Index

User Share Identity, 3-89
User Wavelength Cal Date softkey, 3-91

V

View Trace softkey, 3-92

W

wavelength
 calibration date, 3-93
 referenced value, 3-94
 setting cal source, 3-94
Wavelength Cal Info softkey, 3-93
Wavelength key, 3-92
Wavelength Line Mkr softkey, 3-94
Wavelength menu, 1-26
Wavelength Offset softkey, 3-95
wavelength setup panel
 center wavelength step size, 3-18
 wavelength units, 3-96
web site information, 1-11
Win 32 emulator, 4-9

X

X Win 32 emulator, 4-9
X windows, 4-9, 4-12

Z

Zero Now softkey, 3-7, 3-96
zeroing
 the power meter, 3-56

© Agilent Technologies GmbH 2005

Printed in Germany June 2005
Fourth edition, June 2005



86140-90U03



Agilent Technologies